



U.S. Department of  
Homeland Security

United States  
Coast Guard



## **BOAT CREW HANDBOOK – Navigation and Piloting**

---



*Captain John A. Henriques*

---

**BCH 16114.3  
December 2017**



## John Ashcroft Henriques

John Ashcroft Henriques was one of the most important Revenue Cutter Service officers of the 19<sup>th</sup> century. As founder and first superintendent of the Revenue Cutter Service School of Instruction, forerunner of the modern Coast Guard Academy, he was arguably the most important figure in educating Service officers in seamanship and navigation.

Henriques began his career in March 1863. The next three years proved hectic ones, beginning with a tour on the *James C. Dobbin*, a sailing cutter that played a part in his later career and brief assignments as a junior officer on board cutters *Crawford*, *Northerner* and *John Sherman*. In less than five years, Henriques received promotions from third lieutenant to the rank of captain. This rapid rise testified to Henriques' seafaring experience and command presence. Shortly after the Civil War, a journalist commented, "Captain Henriques is thoroughly posted and *every inch a sailor* [journalist's italics] and a gentleman, as is well known to all who have made his acquaintance."

Captain Henriques saw a lot of sea time in the Atlantic, Pacific, rounding Cape Horn, and in Alaskan waters. In the decade following the War, he commanded four ocean-going cutters, including the *Reliance*. As captain of *Reliance*, he sailed from the East Coast around hazardous Cape Horn to San Francisco. The voyage began August 1867 and included eight brutal days of gale-force winds and heavy seas while the 110-foot topsail schooner slugged her way around "the Horn." A few months after *Reliance* arrived in San Francisco, Henriques sailed for Alaska, becoming one of the first cutter captains to serve in the treacherous waters of that territory, and the first one to enforce U.S. laws in Alaskan waters.

Henriques bore the greatest responsibility for planning, establishment, and oversight of the Revenue Cutter Service School of Instruction. While still in Alaska on board cutter *Richard Rush*, Henriques received orders to Washington, D.C., for the special duty of developing a new Revenue Cutter Service cadet program. With two fellow officers, Henriques devised a system of practical education based on the use of a sail-training ship and Congress passed legislation to establish the school in July 1876. In early December, Henriques convened a board to examine the School's first candidates, which resulted in the Service's first class of cadets.

Early in 1877, Henriques began fitting out *Dobbin* to serve her new role as the School's classroom and living quarters; and he signed on her crew of officers, enlisted men and a surgeon. He also visited the United States Naval Academy, and worked out the final plan for the curriculum, with junior and senior years, one sea term and two academic terms per year. The School of Instruction commenced on May 25<sup>th</sup>, 1877, when nine cadets boarded *Dobbin* and started their course of study under Henriques' supervision. Over Henriques' suggestion of New London, Connecticut, the Service selected New Bedford, Massachusetts, as the School's first homeport.

By 1878, the School of Instruction had enjoyed a year of successful operation. During that year, the venerable old *Dobbin* had served the purpose of school ship. And though the twenty-year-old wooden schooner had proven the importance of practical sailing instruction, the Service built a new purpose-built cutter for cadet training. Henriques took charge of the *Salmon P. Chase* in August 1878, claiming the new 106-foot bark was "one of the most gallant little sea-going vessels he has ever been in; very fast, and in heavy weather always reliable." *Chase* remained the school ship through Henriques' superintendancy, which ended in 1883. In 1900, the School of Instruction moved to Curtis Bay, Maryland; and, ten years later, it moved to its permanent home of New London.

In 1902, after a career of almost forty years, Captain Henriques retired to Connecticut and died just four years later at the age of seventy-nine. As a mentor, advisor and instructor, Henriques influenced generations of revenue cutter officers and ushered in a new age of Service professionalism.





BCH 16114.3

DEC 13, 2017

BOAT CREW HANDBOOK – NAVIGATION AND PILOTING – BCH16114.3

Subj: BOAT CREW HANDBOOK – NAVIGATION AND PILOTING

Ref: a. *Boat Crew Handbook – Seamanship Fundamentals*, BCH16114.4 (series)  
b. *Coast Guard Navigation Standards, COMDTINST M3530.2 (series)*

1. PURPOSE. This Handbook provides the safest, most efficient methods, techniques, and informational guidance possible to navigate boats in maritime environments and situations. Major topics within this handbook are aids to navigation (ATON) and navigation.
2. DIRECTIVES AFFECTED. The Boat Crew Seamanship Manual, COMDTINST M16114.5C, is canceled.
3. DISCUSSION. The subjects and principles discussed herein include U.S. Aids to Navigation system and maritime navigation principles and application.
4. MAJOR CHANGES. First issue.
5. DISCLAIMER. This guidance is not a substitute for applicable legal requirements, nor is it itself a rule. It is intended to provide operational guidance for Coast Guard personnel and is not intended to nor does it impose legally-binding requirements on any party outside the Coast Guard.
6. IMPACT ASSESSMENT. No impact assessment warranted.

7. ENVIRONMENTAL ASPECT AND IMPACT CONSIDERATIONS.

- a. The development of this Handbook and the general guidance contained within it have been thoroughly reviewed by the originating office in conjunction with the Office of Environmental Management, and are categorically excluded (CE) under current USCG CE #33 from further environmental analysis, in accordance with Section 2.B.2. and Figure 2-1 of the National Environmental Policy Act Implementing Procedures and Policy for Considering Environmental Impacts, COMDTINST M16475.1 (series). Because this Handbook contains guidance documents that implement, without substantive change, the applicable Commandant Instruction and other guidance documents, Coast Guard categorical exclusion #33 is appropriate.
- b. This Handbook will not have any of the following: significant cumulative impacts on the human environment; substantial controversy or substantial change to existing environmental conditions; or inconsistencies with any Federal, State, or local laws or administrative determinations relating to the environment. All future specific actions resulting from the general guidance in this Handbook shall be individually evaluated for compliance with the National Environmental Policy Act (NEPA), Department of Homeland Security (DHS) and Coast Guard NEPA policy, and compliance with all other environmental mandates.

7. DISTRIBUTION. No paper distribution will be made of this Handbook. An electronic version will be located on the Office of Boat Forces (CG-731) Portal site:  
<https://cg.portal.uscg.mil/units/cg731/SitePages/Manuals.aspx>.

8. FORMS/ REPORTS. None

9. REQUESTS FOR CHANGES. To recommend edits and changes to this Handbook, please submit a formal request at the following link:  
<https://cg.portal.uscg.mil/communities/bfco/doctrine/SitePages/Home.aspx>.

**RUSH.JAMES.B.1**  
**109192003**  
**J. BRIAN RUSH**  
**U.S. Coast Guard**  
**Chief, Office of Boat Forces**

Digitally signed by RUSH.JAMES.B.1109192003  
DN: c=US, o=U.S. Government, ou=DoD,  
ou=PKI, ou=USCG,  
cn=RUSH.JAMES.B.1109192003  
Date: 2017.12.13 14:04:55 -05'00'



## Table of Contents

<b>CHAPTER 1 INTRODUCTION.....</b>	<b>1-1</b>
SECTION A. PURPOSE OF THIS HANDBOOK .....	1-1
SECTION B. HOW TO USE THIS HANDBOOK .....	1-2
<i>Chapter Layout</i> .....	1-2
<i>Warnings, Cautions, Notes, and Memory Aids</i> .....	1-2
<b>CHAPTER 2 AIDS TO NAVIGATION.....</b>	<b>2-1</b>
SECTION A. U.S. AIDS TO NAVIGATION SYSTEM .....	2-2
<i>Lateral and Cardinal Significance</i> .....	2-3
A.1. IALA-A and IALA-B .....	2-3
A.2. Lateral System .....	2-4
A.3. Cardinal System .....	2-4
<i>General Characteristics of Short-Range AtoN</i> .....	2-5
A.4. Description .....	2-5
A.5. Type .....	2-5
A.6. AtoN Identification (Numbers and Letters) .....	2-5
A.7. Color .....	2-5
A.8. Shape.....	2-5
A.9. Light Colors .....	2-7
A.10. Light Signals .....	2-8
A.11. Sound Signals.....	2-9
A.12. Retroreflective Material .....	2-10
<i>Summary of Lateral Significance of Buoys and Beacons</i> .....	2-10
A.13. Direction of Buoyage .....	2-10
A.14. Marking Starboard Side .....	2-10
A.15. Marking Port Side .....	2-11
A.16. Marking Channel Junction or Bifurcation .....	2-11
A.17. Safe Water Marks .....	2-11
A.18. Isolated Danger Marks .....	2-11
A.19. Special Marks.....	2-12
A.20. Marking Regulated Areas .....	2-12
A.21. Marking Outside Normal Channels.....	2-12
<i>Buoys</i> .....	2-12
A.22. Identification Markings.....	2-12
<i>Beacons</i> .....	2-12
A.23. Beacon Types.....	2-12
A.24. Daybeacons .....	2-13
A.25. Lighted Beacons (Minor Lights) .....	2-13
A.26. Major Lights.....	2-14
A.27. Features.....	2-14
A.28. Light Towers .....	2-15
A.29. Ranges .....	2-16
A.30. Directional Lights.....	2-17
SECTION B. U.S. ATON SYSTEM VARIATIONS .....	2-18
<i>Intracoastal Waterway and Western Rivers</i> .....	2-19
B.1. Intracoastal Waterway .....	2-19
B.2. Western Rivers .....	2-19
<i>Uniform State Waterway Marking System</i> .....	2-20
B.3. Categories of Aid .....	2-20
B.4. USWMS Variations.....	2-20
B.5. USWMS Cardinal Marks.....	2-20
B.6. USWMS Regulatory Marks.....	2-21



B.7. USWMS Mooring Buoys..... 2-21

SECTION C. ELECTRONIC & VIRTUAL AIDS..... 2-22

*Radar Beacons* ..... 2-22

C.1. Radar Beacons ..... 2-22

*Automated Identification System (AIS)*..... 2-23

C.2. Automated Identification System (AIS) AtoN ..... 2-23

C.3. Real and Synthetic AIS AtoN ..... 2-23

C.4. Virtual AIS AtoN ..... 2-23

C.5. AIS AtoN Limitations ..... 2-24

SECTION D. THE LIGHT LIST ..... 2-26

D.1. Contents ..... 2-26

D.2. Numbering Sequence ..... 2-26

D.3. General Information Section ..... 2-26

D.4. Example of Using the *Light List* ..... 2-26

D.5. Example of Local Notice to Mariners Chart Corrections for AIS AtoNs ..... 2-28

D.6. Corrections ..... 2-28

**CHAPTER 3 NAVIGATION ..... 3-1**

SECTION A. THE EARTH AND ITS COORDINATES..... 3-2

A.1. Reference Lines of the Earth ..... 3-2

A.2. Great Circles ..... 3-3

A.3. Parallels ..... 3-4

A.4. Meridians ..... 3-5

A.5. Chart Projections ..... 3-5

SECTION B. NAUTICAL CHARTS ..... 3-8

B.4. Chart Scale ..... 3-13

B.5. Chart Symbols & Abbreviations ..... 3-14

B.6. Accuracy of Charts ..... 3-23

B.7. Electronic Chart Types ..... 3-25

SECTION C. INTEGRATED ELECTRONIC NAVIGATION SYSTEMS ..... 3-27

*System Overview*..... 3-28

C.1. Electronic Navigation..... 3-28

C.2. Interfacing ..... 3-28

*Specific Components*..... 3-29

C.3. Multi-Function Displays ..... 3-29

C.4. Electronic Chart Plotter ..... 3-30

C.5. Heading Sensor/Fluxgate Compass ..... 3-35

C.6. Global Positioning System (GPS)..... 3-35

C.7. Radar ..... 3-39

C.8. Depth Sounder..... 3-46

C.9. Automatic Identification System (AIS) ..... 3-48

C.10. Autopilot..... 3-50

SECTION D. DIRECTION ..... 3-51

*Direction* ..... 3-52

D.1. Cardinal Directions ..... 3-52

D.2. Reference Point/Reference Direction ..... 3-53

D.3. Three Figure Notation ..... 3-53

D.4. Heading Sensor ..... 3-54

*Compass*..... 3-54

D.5. Magnetic Compass ..... 3-54

D.6. Compass Error ..... 3-56

D.7. Variation ..... 3-57

D.8. Deviation ..... 3-59

D.9. Magnetic Compass Deviation Check ..... 3-60

*Adjustments*..... 3-68

D.10. Heading Sensor Adjustment..... 3-68





D.11. Magnetic Compass Adjustment .....	3-68
<i>Course and Bearings</i> .....	3-69
D.12. Course .....	3-69
D.13. Bearings.....	3-74
SECTION E.    POSITION .....	3-78
<i>Introduction</i> .....	3-78
<i>In this Section</i> .....	3-78
<i>Fixing and Plotting</i> .....	3-78
E.1. Fixing Position .....	3-78
E.2. Plotting Symbols on a Paper Chart .....	3-81
<i>Tools</i> .....	3-82
E.3. Paper Chart Plotting Tools .....	3-82
E.4. Finding Latitude of a Position .....	3-84
E.5. Finding the Longitude of a Position .....	3-86
<i>Minutes and Conversion</i> .....	3-87
E.6. Degrees, Minutes, Seconds Scale .....	3-87
E.7. Convert Decimal Degrees .....	3-88
<i>Distance and Bearings</i> .....	3-88
E.8. Distance .....	3-88
E.9. Lines of Position.....	3-94
<i>Fixes</i> .....	3-96
E.10. GPS Fix .....	3-96
E.11. Radar Fixes.....	3-97
E.12. Visual Fix .....	3-101
SECTION F.    NAVIGATION PLANNING .....	3-104
<i>Planning Process</i> .....	3-105
F.1. Navigation Planning Process .....	3-105
F.2. Defining Boat Specifications .....	3-105
<i>Information Prep</i> .....	3-106
F.3. Publications.....	3-106
F.4. Electronic Chart Selection .....	3-109
F.5. Paper Chart Selection .....	3-109
<i>Plotting Components</i> .....	3-113
F.6. Waypoints.....	3-113
F.8. Laying the Trackline .....	3-114
F.9. Turn Bearing / Range .....	3-116
F.10. Danger Bearing/Range .....	3-117
<i>Calculations</i> .....	3-117
F.11. Speed, Time, Distance.....	3-117
<i>Rules</i> .....	3-123
F.12. Three & Six Minute Rules.....	3-123
F.13. Nautical Slide Rule .....	3-125
<i>Critical Considerations</i> .....	3-126
F.14. Fuel Consumption .....	3-126
F.16. Alarms.....	3-127
F.17. Verification.....	3-127
F.18. Briefs.....	3-128
SECTION G.    PILOTING .....	3-129
<i>Approaches to Piloting</i> .....	3-129
G.1. Overview .....	3-129
G.2. Over Reliance .....	3-130
G.3. Technological & Classic Piloting Methods .....	3-131
G.4. Seaman’s Eye.....	3-132
<i>Piloting Tools</i> .....	3-132
G.5. Paper Chart Preparations .....	3-132



G.6. Electronic Charting System.....	3-133
G.8. Radar .....	3-137
<i>Dead Reckoning</i> .....	<b>3-138</b>
G.9. Dead Reckoning.....	3-138
G.10. Estimated Position .....	3-139
G.11. DR Plot.....	3-140
G.12. Running Fix.....	3-141
G.13. Set & Drift.....	3-144
SECTION H. RIVER SAILING.....	3-148
H.1. Special Considerations .....	3-148
H.2. Conditions and Effects.....	3-150
H.3. Locks and Dams.....	3-151
H.4. Safety Considerations Around Navigation Dams.....	3-155
H.5. Common River Sailing Terms.....	3-156
<b>APPENDIX A GLOSSARY</b> .....	<b>A-1</b>
<b>APPENDIX B LIST OF ACRONYMS</b> .....	<b>B-1</b>



## Table of Figures

FIGURE 2-1 PROCEEDING FROM SEAWARD.....	2-4
FIGURE 2-2 CAN AND NUN BUOYS, “WHEN RETURNING FROM SEA” .....	2-6
FIGURE 2-3 DAYBEACON, “WHEN RETURNING FROM SEA” .....	2-7
FIGURE 2-4 LIGHT CHARACTERISTICS.....	2-8
FIGURE 2-5 SAFE-WATER MARK.....	2-11
FIGURE 2-6 LIGHTED BEACON (MINOR ATON) .....	2-13
FIGURE 2-7 SECTOR LIGHT .....	2-15
FIGURE 2-8 USING RANGE LIGHTS .....	2-16
FIGURE 2-9 REGULATORY MARK INFORMATION .....	2-21
FIGURE 2-10 LIGHT LIST EXCERPT.....	2-27
FIGURE 2-11 U.S. AIDS TO NAVIGATION SYSTEM ON NAVIGABLE WATERS, EXCEPT THE WESTERN RIVER SYSTEM .....	2-29
FIGURE 2-12 VISUAL BUOYAGE GUIDE .....	2-30
FIGURE 2-13 HOW THE VISUAL GUIDE WOULD APPEAR ON A NAUTICAL CHART (EXAMPLE).....	2-31
FIGURE 2-14 U.S. AIDS TO NAVIGATION SYSTEM ON THE WESTERN RIVER SYSTEM AND THE UNIFORM STATE WATERWAY MARKING SYSTEM .....	2-32
FIGURE 3-1 EARTH WITH REFERENCE LINES .....	3-2
FIGURE 3-2 PARALLELS OF LATITUDE .....	3-4
FIGURE 3-3 MERIDIANS OF LONGITUDE .....	3-5
FIGURE 3-4 CHART PROJECTIONS.....	3-6
FIGURE 3-5 EARTH’S FOUR HEMISPHERES.....	3-7
FIGURE 3-6 COMPASS ROSE .....	3-8
FIGURE 3-7 CHART ORIENTATION.....	3-11
FIGURE 3-8 TITLE BLOCK OF A CHART.....	3-12
FIGURE 3-9 CHART LETTERING .....	3-16
FIGURE 3-10 SYMBOLS FOR PROMINENT LANDMARKS.....	3-18
FIGURE 3-11 SYMBOLS FOR WRECKS, ROCKS, AND REEFS .....	3-19
FIGURE 3-12 STRUCTURES .....	3-21
FIGURE 3-13 COASTLINES .....	3-22
FIGURE 3-14 VECTOR CHART (ENC).....	3-25
FIGURE 3-15 RASTER CHART (RNC) .....	3-25
FIGURE 3-16 MULTI-FUNCTION DISPLAY SCREENS.....	3-29
FIGURE 3-17 MULTI-FUNCTION DISPLAY / ELECTRONIC CHART PLOTTER (EXAMPLE) .....	3-30
FIGURE 3-18 ELECTRONIC CHART OVERLAYS.....	3-31
FIGURE 3-19 BOAT POSITION SYMBOL .....	3-32
FIGURE 3-20 NAVIGATION DATA.....	3-34
FIGURE 3-21 TIDAL DATA .....	3-34
FIGURE 3-22 GPS SCREEN .....	3-35
FIGURE 3-23 DIFFERENTIAL GLOBAL POSITIONING SYSTEM (DGPS).....	3-36
FIGURE 3-24 WIDE AREA AUGMENTATION SYSTEM (WAAS).....	3-37
FIGURE 3-25 GPS SIGNAL STRENGTH.....	3-38
FIGURE 3-26 RADAR.....	3-39
FIGURE 3-27 GAIN .....	3-40
FIGURE 3-28 VARIABLE RANGE MARKER (VRM).....	3-44
FIGURE 3-29 ELECTRONIC BEARING LINE.....	3-44
FIGURE 3-30 AUTOMATIC RADAR PLOTTING AID (ARPA) .....	3-45
FIGURE 3-31 OFFSET .....	3-46
FIGURE 3-32 NAVIGATIONAL DRAFT .....	3-47
FIGURE 3-33 AIS RECEIVER.....	3-48
FIGURE 3-34 AIS DISTRIBUTED TRACK DATA .....	3-49
FIGURE 3-35 CARDINAL DIRECTIONS .....	3-52



FIGURE 3-36 HEADING SENSOR DATA SHOWN ON GPS DISPLAY .....	3-54
FIGURE 3-37 COMPASS CARD .....	3-55
FIGURE 3-38 LUBBER’S LINE AND MAGNETIC NORTH .....	3-56
FIGURE 3-39 EARTH’S MAGNETIC FIELD AND LINES OF VARIATION .....	3-57
FIGURE 3-40 EASTERLY ERROR VARIATION .....	3-58
FIGURE 3-41 WESTERLY ERROR VARIATION .....	3-58
FIGURE 3-42 DEVIATION CHECK USING RANGES .....	3-60
FIGURE 3-43 DEVIATION CURVE.....	3-65
FIGURE 3-44 EXAMPLE DEVIATION CURVE .....	3-65
FIGURE 3-45 APPLYING COMPASS ERROR, CORRECTING .....	3-71
FIGURE 3-46 APPLYING COMPASS ERROR, UNCORRECTING .....	3-73
FIGURE 3-47 CONVERTING COMPASS BEARING TO MAGNETIC .....	3-75
FIGURE 3-48 CONVERTING RELATIVE BEARINGS TO MAGNETIC; SUMS GREATER THAN 360° .....	3-77
FIGURE 3-49 PLOTTING SYMBOLS.....	3-81
FIGURE 3-50 FINDING LATITUDE OF A POSITION .....	3-84
FIGURE 3-51 FINDING THE LATITUDE OF A POSITION (CONT) .....	3-85
FIGURE 3-52 FINDING THE LONGITUDE OF A POSITION .....	3-86
FIGURE 3-53 CHART SCALES.....	3-90
FIGURE 3-54 MEASURING DISTANCE USING LATITUDE EXAMPLE .....	3-91
FIGURE 3-55 LATITUDE SCALE DISTANCE MEASUREMENT .....	3-92
FIGURE 3-56 MARKING DISTANCE .....	3-92
FIGURE 3-57 GRAPHIC SCALE .....	3-93
FIGURE 3-58 GRAPHIC SCALE DISTANCE MEASUREMENT .....	3-93
FIGURE 3-59 LINE OF POSITION.....	3-94
FIGURE 3-60 PLOTTING LOP .....	3-96
FIGURE 3-61 OBTAINING A RADAR FIX USING VRM .....	3-99
FIGURE 3-62 OBTAINING RADAR FIX USING EBL.....	3-100
FIGURE 3-63 FIX USING VISUAL BEARINGS .....	3-102
FIGURE 3-64 VISUAL FIX USING TERRESTRIAL RANGES.....	3-103
FIGURE 3-65 CHART FOR CORRECTION .....	3-111
FIGURE 3-66 CHART/PUB. CORRECTION RECORD CARD.....	3-111
FIGURE 3-67 WAYPOINT .....	3-113
FIGURE 3-68 SAMPLE TRACKLINE/ROUTE.....	3-114
FIGURE 3-69 LAYING TRACKLINE .....	3-115
FIGURE 3-70 LABELING TRACKLINES.....	3-116
FIGURE 3-71 TURN BEARING / RANGE .....	3-116
FIGURE 3-72 DANGER BEARING / RANGE.....	3-117
FIGURE 3-73 SPEED, TIME, DISTANCE TRIANGLE .....	3-118
FIGURE 3-74 NAUTICAL SLIDE RULE .....	3-125
FIGURE 3-75 CROSS TRACK ERROR (XTE) .....	3-134
FIGURE 3-76 GPS HIGHWAY DISPLAY .....	3-136
FIGURE 3-77 LABELLING A DR POSITION & COURSE.....	3-138
FIGURE 3-78 ESTIMATED POSITION.....	3-139
FIGURE 3-79 SAMPLE DR PLOT.....	3-141
FIGURE 3-80 RUNNING FIX .....	3-142
FIGURE 3-81 CURRENT TRIANGLE .....	3-145
FIGURE 3-82 PLOTTING SET AND DRIFT TO DETERMINE COURSE TO STEER .....	3-146
FIGURE 3-83 COMPENSATING FOR SET AND DRIFT .....	3-147
FIGURE 3-84 SAMPLE RIVER CHART .....	3-149
FIGURE 3-85 ROLLER GATE DAM .....	3-152
FIGURE 3-86 STANDARD LOCKING SIGNALS.....	3-154



## Table of Tables

TABLE 2-1 IALA-A AND IALA-B SYSTEMS .....	2-3
TABLE 2-2 AIS OR VIRTUAL AIDS TO NAVIGATION (ATON) .....	2-24
TABLE 2-3 LIGHT LIST INDEX.....	2-27
TABLE 3-1 BOTTOM COMPOSITION.....	3-20
TABLE 3-2 DEVIATION WORK TABLE .....	3-62
TABLE 3-3 OBSERVATION TABLE.....	3-64
TABLE 3-4 DEVIATION TABLE .....	3-68
TABLE 3-5 SPEED VS. RPMs CONVERSION (EXAMPLE).....	3-127
TABLE 3-7 TECHNOLOGICAL & CLASSIC NAVIGATION ENVIRONMENTS .....	3-131
TABLE 3-8 COMMON RIVER SAILING TERMS.....	3-156
TABLE 3-9 (CONTINUED) COMMON RIVER SAILING TERMS.....	3-157





---

---

# CHAPTER 1

## Introduction

---

---

### Section A. Purpose of this Handbook

---

**Introduction** The purpose of this handbook is to provide the safest, most efficient methods, techniques, and informational guidance possible to navigate boats in maritime environments and situations. Major topics within this handbook are aids to navigation (ATON) and navigation.

**In this Section** This Section contains the following information:

Title	See Page
<a href="#">Procedures</a>	1-1

**Procedures** This Handbook is not intended to cover every contingency that may be encountered during mission execution or training. Successful operations require the exercise of good safety practices, sound judgment and common sense at all levels of command.

---



---

## Section B. How to Use this Handbook

---

**Introduction** Each Chapter of this Handbook includes its own table of contents and is divided into sections. A glossary and list of acronyms are located at the end of this Handbook.

---

**In this Section** This Section contains the following information:

Title	See Page
<a href="#">Chapter Layout</a>	1-2
<a href="#">Warnings, Cautions, Notes, and Memory Aids</a>	1-2

---

**Chapter Layout** The first page of each Chapter includes an *Introduction*, and an *In this Section* (which lists each section title).

The first page of each chapter includes an *Introduction*, an *In this Chapter*, and *References for this Chapter*, as applicable.

The first page of each section includes an *Introduction*, an *In this Section*, and *References for this Section*, as applicable.

In the left column of each page is the block title, which provides a descriptive word or phrase for the corresponding block of text across from it.

---

**Warnings, Cautions, Notes, and Memory Aids** The following definitions apply to “Warnings, Cautions, Notes, and Memory Aids” found throughout the Handbook.

---

**WARNING** 

Operating procedures or techniques that must be carefully followed to avoid personal injury or loss of life.

---

**CAUTION!**

Operating procedures or techniques that must be carefully followed to avoid equipment damage.

---

**NOTE** 

An operating procedure or technique that is essential to emphasize.

---

**MEMORY AID** 

A slogan, acronym, or other device that helps commit a principle to memory.

---





---

## CHAPTER 2

### Aids to Navigation

---

**Introduction**

This chapter introduces the aids to navigation (AtoN) used in the United States. AtoN are devices or marks, both physical and virtual, that assist mariners in determining their vessel's position, or course, or to warn of dangers, obstructions, or regulatory requirements affecting safe navigation. In the U.S., the Coast Guard is responsible for servicing and maintaining AtoN under federal jurisdiction. This includes both short and long-range navigation systems found in the navigable waters, along the U.S. coast, Intracoastal Waterway (ICW) system, and the Western Rivers system.

Lakes and inland waterways that fall under state jurisdiction use the Uniform State Waterway Marking System (USWMS).

**In this Chapter**

This chapter contains the following sections:

Section	Title	See Page
A	<a href="#">U.S. Aids to Navigation System</a>	2-2
B	<a href="#">U.S. AtoN System Variations</a>	2-18
C	<a href="#">Electronic &amp; Virtual Aids</a>	2-22
D	<a href="#">The Light List</a>	2-26

---



---

## Section A. U.S. Aids to Navigation System

---

### Introduction

Buoys, beacons, and other short-range AtoN are used the same way signs, lane separations, and traffic lights guide motor vehicle drivers. Together, these AtoN make up the short-range AtoN system, which uses charted reference marks to provide information for safely navigating waterways. In the U.S., short-range aids conform to the International Association of Marine Aids to Navigation and Lighthouse Authorities (IALA) Region B. This is called System B, the U.S. Lateral System, or the U.S. Aids to Navigation System. The Coast Guard maintains short-range aids to provide:

- (01) Daytime visual system of daymarks, beacons and buoys.
- (02) Nighttime visual system of lights and retroreflective signals.
- (03) Radar system of radar reflectors and RACONs (radar beacons).
- (04) A sound system of various non-directional sound producing devices, though not required by IALA.
- (05) Transmission of Automated Identification System (AIS) AtoN messages and marine safety information

**Figure 2-11** through **Figure 2-14** provide color representations of AtoN for the various U.S. systems and how they would appear on a nautical chart.

### NOTE

Not all U.S. aids are in the IALA B System. Aids in Guam, Tinian and other outlying areas are in the IALA A System.

### NOTE

“Natural AtoN” are charted prominent structures or landmarks that supplement the short range AtoN system. They are not a part of IALA System B, and are not a Coast Guard responsibility to service or maintain.

### In this Section

This section contains the following information:

Title	See Page
<a href="#">Lateral and Cardinal Significance</a>	2-3
<a href="#">General Characteristics of Short-Range AtoN</a>	2-5
<a href="#">Summary of Lateral Significance of Buoys and Beacons</a>	2-10
<a href="#">Buoys</a>	2-12
<a href="#">Beacons</a>	2-12



## Lateral and Cardinal Significance

### A.1. IALA-A and IALA-B

Prior to the mid-1970's, there were over 30 different navigation systems in use around the world. To reduce confusion, IALA established two systems of buoyage for conveying navigation information to mariners. The IALA System A and B were established, with the U.S. complying with the IALA B System.

The IALA-A and IALA-B systems use the Lateral and Cardinal Systems to define the conventions of buoyage, and to mark channels with AtoN. "Lateral significance" or "cardinal significance" means that the rules for the Lateral or Cardinal System apply in that instance. However, if something has no lateral or cardinal significance, the respective system's rules do not apply to the situation. The differences between the markings and conventions used in the Lateral and Cardinal Systems are discussed in the following paragraphs. Table 2-1 briefly describes the IALA Systems A and B:

	<b>Buoyage System</b>	
	<b>IALA-A System</b>	<b>IALA-B System</b>
<b>Location</b>	Europe, Africa, Australia, New Zealand, and most of Asia	North and South America, Japan, South Korea, and the Philippines
<b>Information shown by</b>	Buoy shapes, colors, and if lighted, rhythm of flashes and colored lights	
<b>Topmarks</b>	Small distinctive shapes above the basic aid that assist in identification of the aid.	
<b>Marks</b>	Cardinal and lateral marks	Mostly lateral, some cardinal in the Uniform State Waterway Marking System (USWMS)
<i>Cardinal marks have black and yellow horizontal bands regardless of the IALA system.</i>		
<b>When entering from seaward:</b>		
	<b>IALA-A System</b>	<b>IALA-B System</b>
<b>Keep red buoys to</b>	Port	Starboard, "red, right, returning"
<b>Keep green buoys to</b>	Starboard	Port

**Table 2-1**  
**IALA-A and IALA-B Systems**



## A.2. Lateral System

In the lateral system, buoys and beacons indicate the sides of the channel or route relative to a conventional direction of buoyage (usually upstream). They also mark junctions, a point where two channels meet when proceeding seaward; or bifurcations, the point where a channel divides when proceeding from seaward, or the place where two tributaries meet.

In U.S. waters, AtoN use the IALA-B system (see [Table 2-1](#)) of lateral marks with few exceptions, arranged in geographic order known as the “conventional direction of buoyage” ([Figure 2-1](#)). Under this, the memory aid 3R rule of “red, right, returning” applies when a vessel is returning from seaward. This means, when returning from sea, keep red markers to the right of the vessel from:

- (01) North to south along the Atlantic Coast.
- (02) South to north and east to west along the Gulf Coast.
- (03) South to north and east to west along the Pacific Coast.
- (04) East to west in the Great Lakes except for Lake Michigan which is north to south.

## A.3. Cardinal System

The Cardinal System uses a buoy to indicate the location of a danger relative to the buoy itself. In the U.S., the USWMS uses cardinal marks on waters where a state exercises sole jurisdiction. The colors of these marks differ from those of IALA. For instance, a white buoy with a black top indicates unsafe water to the south and west. Various countries throughout the world, including Canada, Bermuda, and the Bahamas, also use Cardinal marks along with lateral marks. Cardinal marks are not used on waters where the U.S. Coast Guard maintains short-range AtoN.



Figure 2-1  
Proceeding From Seaward



## General Characteristics of Short-Range AtoN

---

**A.4. Description** Aids to navigation have many different characteristics. An aid's color, size, light, and sound signify what mariners should do when they see it. Characteristics of short-range aids used in the U.S. are described in the following paragraphs.

---

**A.5. Type** The location and the intended use determine which one of the two types of AtoN will be placed in a spot or waterway:

- (01) Floating (buoy).
  - (02) Fixed (beacon).
- 

**A.6. AtoN Identification (Numbers and Letters)**

Solid red AtoN buoys and beacons bear even numbers and all solid green AtoN bear odd numbers. No other AtoN are numbered. When proceeding from seaward toward the direction of conventional navigation, the numbers increase. Numbers are kept in approximate sequence on both sides of the channel. Letters may be used to augment numbers when lateral AtoN are added to channels with previously completed numerical sequences. For instance, a buoy added between R"4" and R"6" in a channel would be numbered R"4A". Letters will also increase in alphabetical order.

Not every buoy or beacon is numbered. Preferred channel, safe water marks, isolated danger, special marks, and information/regulatory AtoN use only letters.”

---

**A.7. Color** During daylight hours, the color of an AtoN indicates the port or starboard side of a channel, preferred channels, safe water, isolated dangers, and special features. Only red or green buoys, or beacons fitted with red or green dayboards, have lateral significance.

---

**A.8. Shape** Shapes of buoys and beacons help identify them from a distance or at dawn or dusk, when colors may be hard to see. Like other characteristics of AtoN, mariners should not rely solely on shape to identify an aid.

---



A.8.a.  
Cylindrical  
Buoys (Can)

Cylindrical buoys, often referred to as “can buoys,” are unlighted AtoN. When used as a lateral mark, they indicate the left side of a channel or of the preferred channel when returning from seaward. They are painted solid green or have green and red horizontal bands; the topmost band is always green. Can buoys are also used as unlighted special marks and will be colored based on their use (**Figure 2-2**).

A.8.b. Conical  
Buoys (Nun)

Conical buoys, often referred to as “nun buoys,” are unlighted AtoN. When used as a lateral mark, nun buoys indicate the right side of a channel or of the preferred channel when returning from seaward. They are painted solid red or red and green with horizontal bands and always with a red topmost band. Nun buoys are also used as unlighted special marks and will be colored based on their use (**Figure 2-2**).

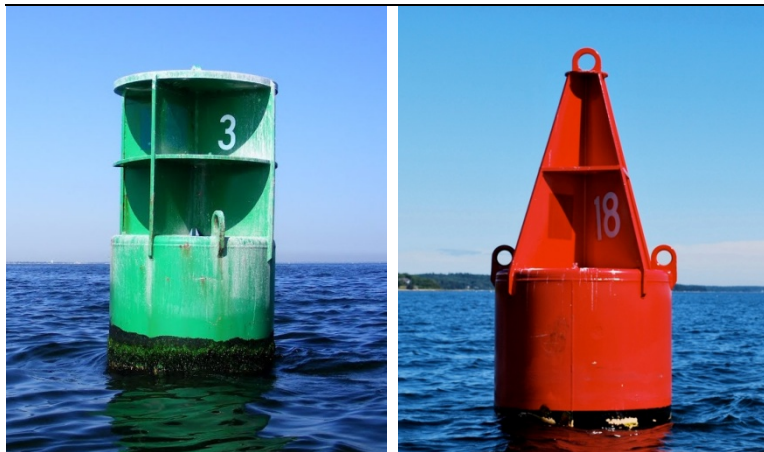

CAN BUOY (LEFT)

NUN BUOY (RIGHT)

**Figure 2-2**  
**Can and Nun Buoys, “When Returning From Sea”**

A.8.c.  
Miscellaneous  
Buoys

The Coast Guard and other agencies place (station) specialty buoys for operational and developmental uses, and for research purposes. In many instances, the buoy used is a standard buoy modified for specialized use. There are several examples of specialty buoys:

- (01) Fast water buoys.
- (02) Discrepancy buoys.
- (03) Weather/oceanographic buoys.
- (04) Mooring buoys.



A.8.d. Beacons Beacons have dayboards attached to a structure. When returning from sea, a triangular shaped dayboard marks the starboard side, and a square shaped dayboard marks the port side of the channel (see [Figure 2-3](#)).

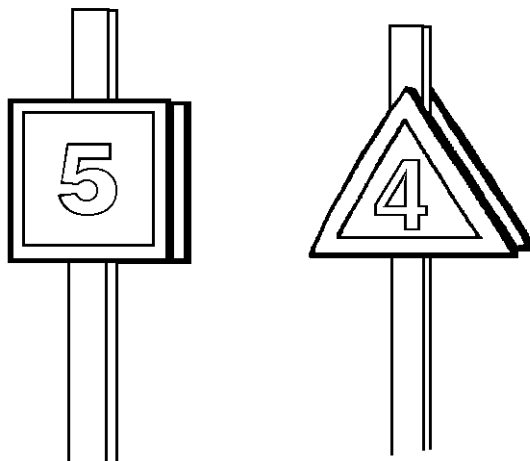

Figure 2-3  
Daybeacon, “When Returning From Sea”

### A.9. Light Colors

Though there are white and yellow lights, only AtoN with green or red lights have lateral significance. When proceeding in the conventional direction of buoyage, AtoN will display the following light colors:

- (01) Green.
- (02) Red.
- (03) White and yellow.

#### A.9.a. Green

Green lights mark port sides of channels and wrecks or obstructions. When proceeding from seaward, these aids are passed by keeping them on the port side. Green lights are also used on preferred channel marks where the preferred channel is to starboard. When proceeding along the conventional direction of buoyage (from seaward), a preferred channel mark fitted with a green light would be flashing 2+1 with the color of the preferred channel being kept on the port side.

#### A.9.b. Red

Red lights mark starboard sides of channels and wrecks or obstructions. When proceeding from seaward, these aids would be passed by keeping them on the starboard side. Red lights are also used on preferred channel marks where the preferred channel is to port. When proceeding along the conventional direction of buoyage (from seaward), a preferred channel mark fitted with a red light would be flashing 2+1 with the color of the preferred channel kept on the starboard side.

#### A.9.c. White and Yellow

White and yellow lights have no lateral significance. However, the characteristic (rhythm) of the light does give information such as safe water, danger, or special purpose. The publication called *Light List*, discussed in



---

**Section D** of this Chapter, provides more details.

---

### A.10. Light Signals

Lights are installed on AtoN to provide signals to distinguish one navigation light from another, or from the general background of shore lights.

---

#### A.10.a. Light Characteristics

Lights displayed from AtoN have distinct characteristics which help in identifying them (**Figure 2-4**). AtoN with lateral significance display flashing, quick, occulting, or isophase light rhythms.

---

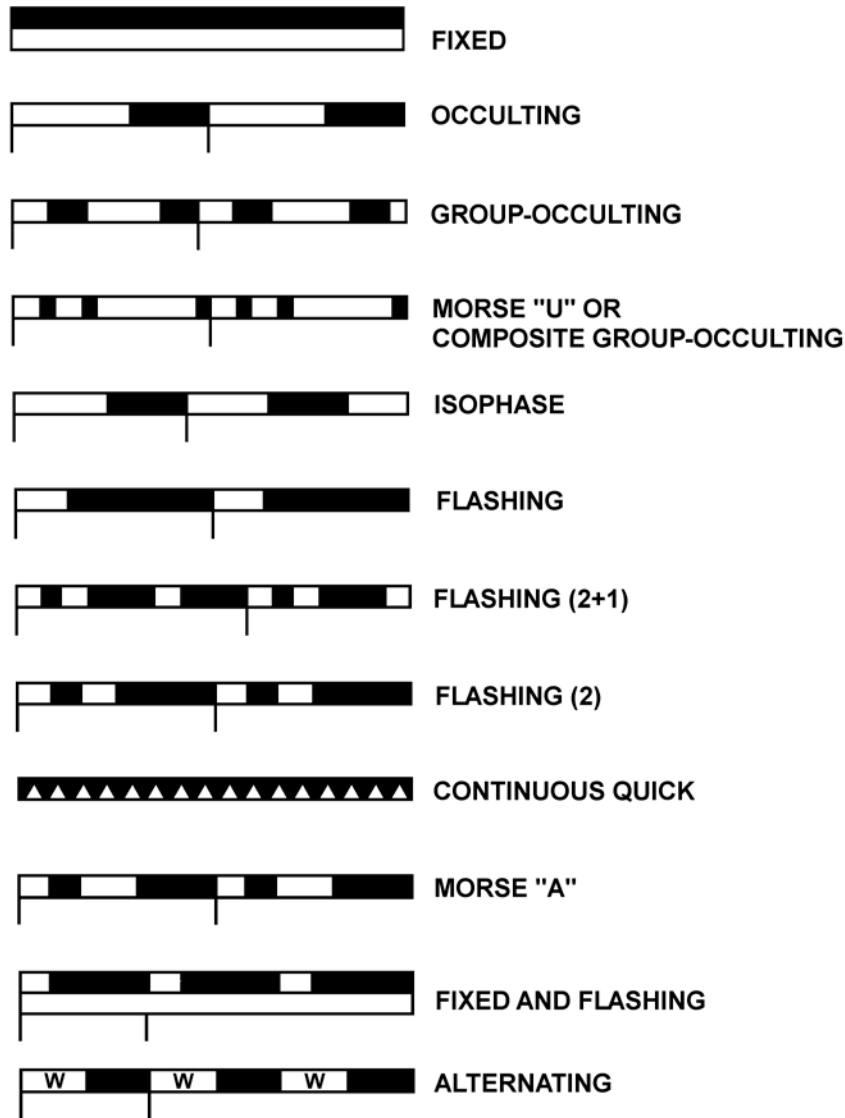

Figure 2-4  
Light Characteristics





A.10.b. Light Identification

To identify a light, the following information should be determined:

<b>Color</b>	Color of the light.
<b>Characteristic</b>	Pattern of flashes or eclipses (dark periods) observed from the start of the one cycle to the start of the next cycle.
<b>Duration</b>	Length of time for the light to go through one complete cycle of changes.
Example: Buoy “8” displays one single flash of red every 4 seconds. That light color and rhythm information is indicated on the chart as: R"8" Fl R 4s	

A.11. Sound Signals

Though not a requirement of IALA B system, in the U.S., some AtoN have sound signals to provide information to mariners during periods of restricted visibility. Different types of devices are used to produce these sounds. Sound signals may be activated as follows:

- (01) Continuously (bell, gong, or whistle buoy).
- (02) Manually.
- (03) Remotely.
- (04) Automatically (when equipped with a fog detector).

Sound signals can be identified by their tone and phase characteristics. Horns, sirens, whistles, bells, and gongs produce distinct sound signals. The sound signal characteristics for specific AtoN are briefly described on the chart, and in length in Column 8 of the *Light List*. Unless it is specifically stated that a signal “Operates Continuously” or the signal is a bell, gong, or whistle, signals will only operate in fog, reduced visibility, or adverse weather.

**NOTE**

A bell, gong, and whistle buoy are activated by the motion of the sea and may not produce a sound signal in calm seas.



Device	Characteristic
<b>Tone Characteristics</b>	
Electronic horns	Pure tone
Sirens	Wail
Whistle buoys	Loud moaning sound
Bell buoys	One tone
Gong buoys	Several tones
<b>Phase Characteristics</b>	
Fixed structures	Produce a specific number of blasts and silent periods every minute.
Buoys with a bell, gong, or whistle	Are wave actuated and do not produce a regular characteristic.
Buoys with electronic horn	Operate continuously.

**A.12. Retroreflective Material**

Most minor AtoN (buoys and beacons) are fitted with retroreflective material to increase their visibility at night. While this material does not produce light on its own, when illuminated by a light source (searchlight), it reflects the light back towards the operator with great intensity.

In most cases, the color of the reflective material panel is the same as the surface it covers (red on red, green on green). Numbers and letters found on buoys will be silver/white. Daybeacons are outlined with retroreflective material and will be identified with numbers or letters made of the same color as the beacon (see 0). Exceptions are found on some aids.

**Summary of Lateral Significance of Buoys and Beacons**

**A.13. Direction of Buoyage**

While proceeding in the conventional direction of buoyage in IALA System B, boat crews will see the following AtoN:



Red, right, returning.

**A.14. Marking Starboard Side**

Red buoys and beacons with triangular shaped red dayboards mark the starboard side of a channel when returning from seaward. This is the red, right, returning rule. AtoN displaying these characteristics are kept to starboard when returning from seaward.



---

**A.15. Marking Port Side**

Green buoys and beacons with square shaped green dayboards mark the port side of a channel when returning from seaward.

---

**A.16. Marking Channel Junction or Bifurcation**

Red and green, or green and red, horizontally banded buoys and beacons are called preferred-channel marks. They are used to indicate a channel junction or bifurcation (point where a channel divides or where two tributaries meet). They may also mark wrecks or obstructions and may be passed on either side. When returning from sea, and the topmost band is:

- (01) Green: keep the aid to port to follow the preferred channel.
  - (02) Red: keep the aid to starboard to follow the preferred channel.
- 

**A.17. Safe Water Marks**

Safe water marks are buoys with alternating red and white vertical stripes, and beacons with red and white vertically striped dayboards (**Figure 2-5**). They also mark a mid-channel, fairway, channel approach points and the “In” and “Out” channels of a “Traffic Separation Scheme.” See buoy “N” in **Figure 2-5**. If lighted, they will display a white light with the characteristic Morse Code “A”. Safe water buoys (lighted or not) should be fitted with a red sphere as a visually distinctive top mark. Safe water marks are not laterally significant.

---



**Figure 2-5**  
Safe-Water Mark

---

**A.18. Isolated Danger Marks**

Black and red horizontally banded buoys are called “Isolated Danger Marks”. They are used to mark isolated dangers (wrecks or obstructions) which have navigable water all around. Isolated danger marks display a white light with a “group-flashing” characteristic; and are fitted with a visually distinctive topmark, consisting of two black spheres, one above the other (**Figure 2-11**).

**NOTE** 

This buoy marking system is not used in the Western River System.

---



---

### A.19. Special Marks

Yellow buoys and beacons are called “special marks”. They mark anchorages, dredging/spoil areas, fishnet areas, and other special areas or features. When lighted, special marks will display a yellow light with a Fixed (“F”) or Flashing (“Fl”) characteristic. Special marks may also be used to mark the center of the traffic separation scheme.

---

### A.20. Marking Regulated Areas

Information and regulatory buoys and beacons indicate various warnings or regulatory matters. They are colored with white and orange shapes (**Figure 2-11**). They will only display a white light and may display any light rhythm except quick flashing.

---

### A.21. Marking Outside Normal Channels

Beacons with no lateral significance may be used to supplement lateral AtoN outside normal routes and channels. Daymarks for these aids are diamond shaped and will either be red and white, green and white, or black and white (**Figure 2-11**).

---

## Buoys

### A.22. Identification Markings

Buoys are floating AtoN anchored at a given position to provide easy identification by mariners. The significance of an unlighted buoy can be determined by its shape. These shapes are only laterally significant when associated with laterally significant colors such as green or red. Buoys are useful AtoN, but should never be relied upon exclusively for navigation.

When a buoy is “watching properly”, it is marking its charted position “on Station” and properly displaying all other distinguishing characteristics. Heavy storms, collisions with ships, and severe ice conditions may move a buoy “off Station”. Heavy storms may also shift the shoal a buoy marks into the channel. It is important to remember, even heavily anchored buoys fail.

---

## Beacons

### A.23. Beacon Types

Beacons are fixed AtoN structures attached directly to the earth’s surface. The design, construction, and characteristics of these beacons depend on their location and relationship to other AtoN in the area. Strictly defined, a beacon is any fixed unlighted AtoN (daybeacon) or minor light (lighted) AtoN of relatively low candlepower. The following types of beacons are used in the U.S.:

- (01) Daybeacons.
  - (02) Lighted beacons (minor lights).
  - (03) Major lights.
  - (04) Light towers.
-



**A.24.  
Daybeacons**

Daybeacons are unlighted fixed structures fitted with a dayboard for daytime identification. To increase their visibility in darkness, dayboards are fitted with retroreflective material. Daybeacons are built on different types of structures:

- (01) Single pile with a dayboard on the top.
- (02) Multi-pile structure.
- (03) Tower.
- (04) Structure of masonry or steel.

**A.25. Lighted  
Beacons (Minor  
Lights)**

Just as daybeacons are sometimes substituted for unlighted buoys, lighted beacons are substituted for lighted buoys. Their structures are similar to daybeacons (**Figure 2-6**). Lighted beacons are used with other lateral aids (buoys) marking a channel, river, or harbor. In most instances, the lights have similar candlepower to those lights on buoys in the same area. They can also be used to mark isolated dangers.

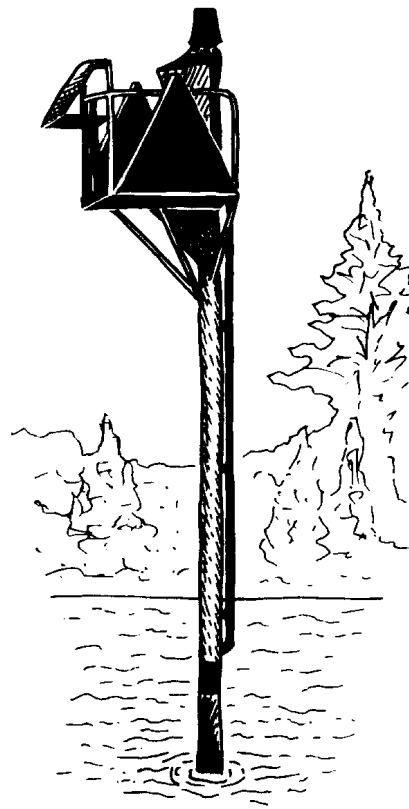

Figure 2-6  
Lighted Beacon (Minor AtoN)



---

## A.26. Major Lights

Major lights display a light of moderate to high candlepower. They may also have high intensity audible signaling devices, radiobeacons and radar beacons (RACONs). Major light structures, lighthouses for instance, enclose, protect, and house their signaling devices. In their surroundings, major light structures have visually distinctive appearances. Determining whether a light is major, or minor, depends upon its candlepower and the luminous range of the light. A light's category may change if fitted with a higher or lower candlepower light.

Major lights rarely have lateral significance and fall into two broad categories. They are used as coastal or seacoast lights and are often referred to as primary AtoN. They mark headlands and landfalls and are designed to assist vessels during coastal navigation or when approaching from seaward. They are also used as "Inland Major Lights" and are found in bays, sounds, large rivers, and coastal approaches. As an inland major light, they serve a variety of functions:

- (01) Obstruction mark.
- (02) Sector light.
- (03) Reference mark from which a visual bearing or range can be obtained.

---

## A.27. Features

Besides the main signal light, additional features found on some major lights help provide more detailed information concerning the surrounding area (colored light sectors) or provide a secondary light source should the primary lantern fail.

---



A.27.a. Sector Lights

Sector lights are sectors of color that are displayed on lantern covers of certain lighthouses to indicate danger bearings. Sector bearings are true bearings and are expressed as “bearings from the vessel towards the light.” A red sector indicates a vessel would be in danger of running aground on rocks or shoals while in the sector. Red sectors may be only a few degrees in width when marking an isolated obstruction (**Figure 2-7**)

A.27.b. Emergency Lights

Reduced intensity emergency lights are displayed if the primary lights are extinguished. They may or may not have the same characteristics as the primary lights. The characteristics of emergency lights are listed in Column 8 of the *Light List* (**Figure 2-7**).

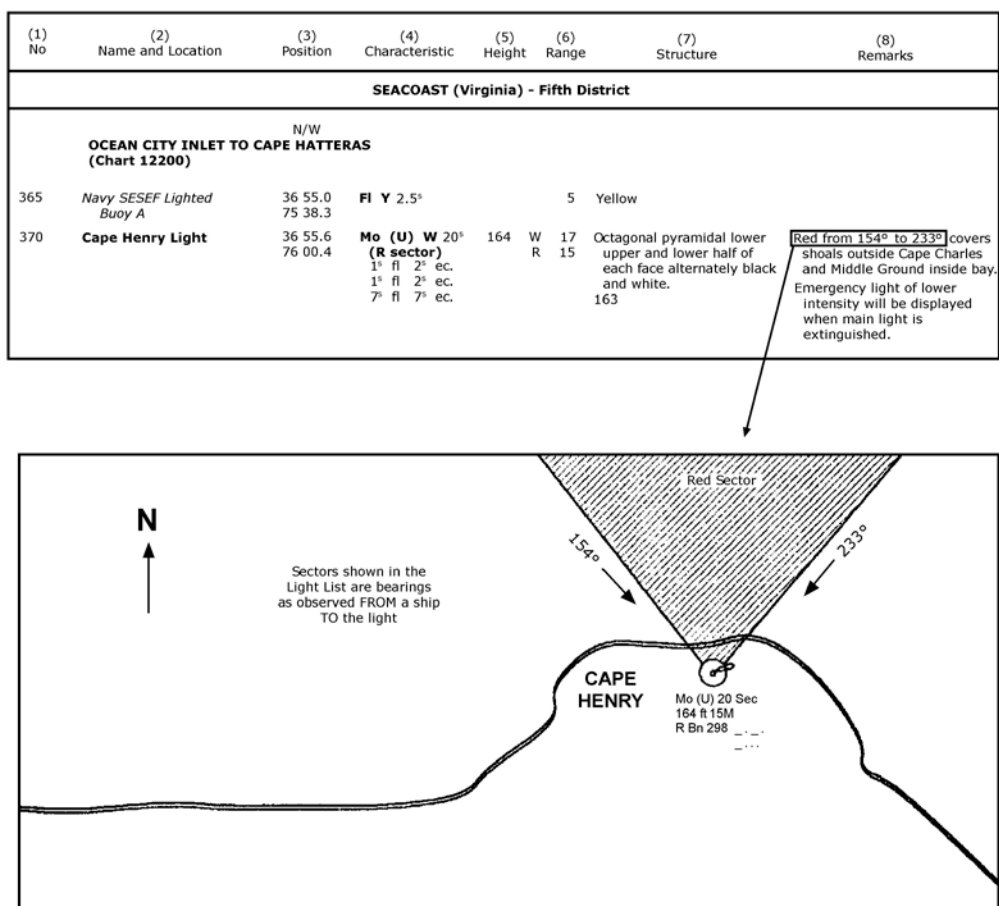

**Figure 2-7**  
Sector Light

A.28. Light Towers

Light towers replaced lightships and are located in deepwater to mark shoals and heavily traveled sea lanes. The foundation or legs of these towers are fixed to the bottom. They are equipped with signals comparable to major lights.



### A.29. Ranges

Ranges are pairs of beacons located to define a line down the center of a channel or harbor entrance. They are usually lighted and arranged so that one mark is behind and higher than the other mark. When both markers of the range are in line, a vessel's position is along a known LOP. Ranges are located on specially built structures, existing AtoN structures, or structures such as buildings or piers. Ranges are found in entrance channels to harbors, piers, or successive straight reaches. Range marks are located so that when viewed from the channel the upper mark is above, and a considerable distance beyond, the lower mark.

If...	Then...
the two marks are vertically aligned,	the upper (rear) mark appearing directly above the lower (front) mark, the vessel is in the center of the channel ( <b>Figure 2-8</b> ).
the upper mark is seen to the left of the lower mark,	the vessel is to the left of the center of the channel.
the upper mark is to the right of the lower mark,	the vessel is to the right of the center of the channel.

### CAUTION !

The limits of a range can be determined only by checking the chart. They show the fairway or reach of the channel marked by the range. This area will be marked by a leading line (solid line) on the chart. At the turn, the range will be marked by a dotted line (**Figure 2-8**).

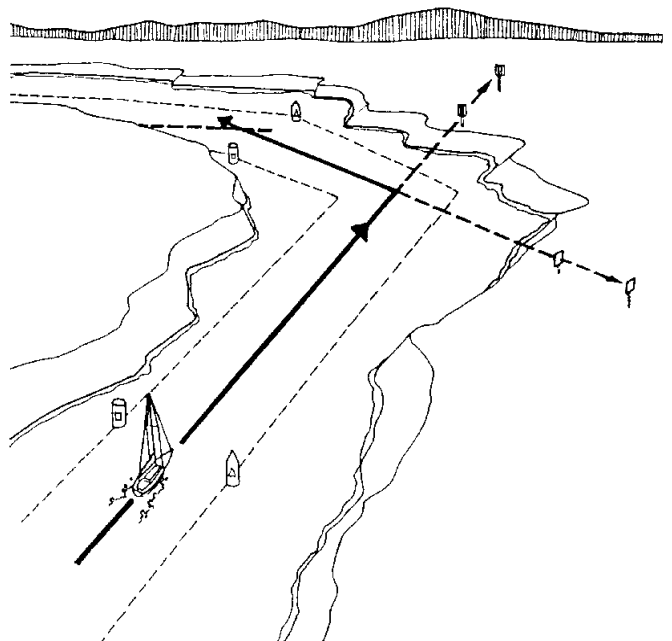

**Figure 2-8**  
**Using Range Lights**





---

**A.29.a. Range Characteristics**

Ranges are considered to be non-lateral AtoN. Some ranges have rectangular daymarks that are striped in various colors (**Figure 2-11**). Most are lit 24 hours per day and may display either red, green, or white lights or combinations of the same. The *Light List* should be consulted for the light characteristics and color combinations displayed on the daymarks.

---

**A.30. Directional Lights**

Some structures have a directional light, a single light with a special lens, with a narrow white light beaming in a specific direction. On either side of the white beam is a red or green light. The width of the sector varies with the particular location. The *Light List* and chart should be checked for specific information.

---



---

## Section B. U.S. AtoN System Variations

---

**Introduction** Though the system of AtoN used in the U.S. and its territories consists of buoys and beacons conforming to IALA System B requirements; the waterway systems in the U.S. have variations that are exclusively used in the U.S. system. Some of these variations can be seen in the following figures located at the end of this Chapter.

**Figure 2-11**

U.S. Aids to Navigation System on Navigable Waters, Except the Western River System

**Figure 2-12**

Visual Buoyage Guide

**Figure 2-13**

How the Visual Guide Would Appear on a Nautical Chart (Example)

**Figure 2-14**

U.S. Aids to Navigation System on the Western River System and the Uniform State Waterway Marking System

---

**In this Section** This section contains the following information:

Title	See Page
Intracoastal Waterway and Western Rivers	2-19
Uniform State Waterway Marking System	2-20

---



## Intracoastal Waterway and Western Rivers

**B.1. Intracoastal Waterway** Extending some 2,400 miles along the Atlantic and Gulf coasts of the U.S., the Intracoastal Waterway (ICW) is a largely sheltered waterway, suitable for year-round use. AtoN used to mark the ICW use the same coloring, numbering, and conventional direction of buoyage found in the U.S. AtoN System with the following additional characteristics:

- (01) Special markings consisting of yellow squares and triangles are used so that vessels may readily follow the ICW.
- (02) The yellow square shows that the aid should be kept on the left side when traveling north to south/east to west.
- (03) The yellow triangle shows that the aid should be kept on the right side when traveling north to south/east to west.
- (04) Non-lateral aids in the ICW, such as ranges and safe-water marks, are marked with a yellow horizontal band.

---

### **B.2. Western Rivers**

The western rivers marking system is used on the Mississippi River and tributaries above BAtoN Rouge, Louisiana, and certain other rivers which flow towards the Gulf of Mexico. The western rivers system varies from the U.S. AtoN System as follows:

- (01) Buoys are not numbered.
  - (02) Lighted beacons and daybeacons are numbered but have no lateral significance. (The numbers relate to the distance up or downstream from a given point in statute miles).
  - (03) Red and green diamond-shaped daymarks, as appropriate, are used to show where the channel crosses from one side of the river to the other.
  - (04) Lights on green buoys and beacons are colored green or white (for crossings) and have a flashing (Fl) characteristic.
  - (05) Lights on red buoys and beacons are colored red or white (for crossings) and have a group flashing (Gp Fl) characteristic.
  - (06) Isolated danger marks are not used.
-



## Uniform State Waterway Marking System

### B.3. Categories of Aid

The Uniform State Waterway Marking System (USWMS) is designed for use by many types of operators and small vessels on lakes and inland waterways not shown on nautical charts. The conventional direction of buoyage in the USWMS is considered upstream or towards the head of navigation. This system has two categories of aids:

- (01) System of AtoN compatible with and supplements the U.S. lateral system in states' waters, not federal jurisdiction.
- (02) System of regulatory markers that warn of danger or provide general information and directions (**Figure 2-11**).

---

### B.4. USWMS Variations

There are three USWMS variations to the U.S. AtoN System:

- (01) On a well-defined channel, solid-colored red and black buoys are established in pairs (gate buoys), marking each side of the navigable channel.
- (02) The color black is used instead of green.
- (03) The shape of the buoy has no significance.

---

### B.5. USWMS Cardinal Marks

When there is no well-defined channel or when there is an obstruction whose nature and location allows it to be approached by a vessel from more than one direction, AtoN with cardinal marks may be used. The USWMS provides for three aids with marks that have cardinal significance:

- (01) A white buoy with a red top represents an obstruction and the buoy should be passed on the south or west.
  - (02) A white buoy with a black top represents an obstruction and the buoy should be passed to the north or east.
  - (03) A red and white vertically striped buoy indicates an obstruction exists between that buoy and the nearest shore.
-



## B.6. USWMS Regulatory Marks

USWMS regulatory marks are white with two international orange horizontal bands completely around the buoy circumference. One band is near the top of the buoy while the second band is just above the waterline. Geometric shapes are placed on the buoy's body and are colored international orange (**Figure 2-9**). There are four basic geometric shapes authorized for these marks and each one has a specific meaning associated with it. These are:

- (01) A vertical open-faced diamond shape having a cross centered in the diamond means that vessels are excluded from entering the marked area.
- (02) A vertical open-faced diamond shape means danger.
- (03) A circular shape indicates a control zone where vessels in the area are subject to certain operating restrictions.
- (04) A square or rectangular shape is used to display information such as direction and/or distances to a location. (Information and regulatory marks can also be used in waters outside USWMS waters (e.g., federal channels which use the U.S. AtoN system.)

**NOTE**  Regulatory marks are displayed on beacons as well as buoys.

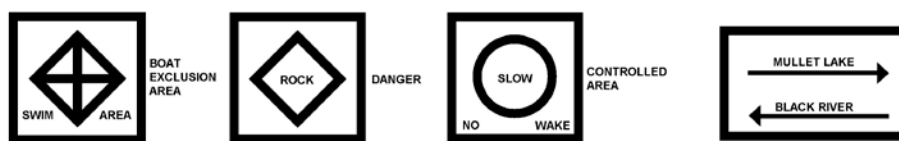

**Figure 2-9**  
**Regulatory Mark Information**

## B.7. USWMS Mooring Buoys

Mooring buoys in USWMS are white with a horizontal blue band midway between the waterline and the top of the buoy, and display a slow-flashing white light when lighted. Mooring buoys in federal waters (U.S. AtoN system) also display white with a horizontal blue band.



---

## Section C. Electronic & Virtual Aids

---

**Introduction** The science of locating position on the water is under constant change and improvement. The use of electronic signals to assist the mariner has come a long way in the last decade.

**NOTE** 

No navigation system is perfect, so a rhyme for the wise: “A mariner who navigates by only system, may soon find they are way off position.”

---

**In this Section** This section contains the following information:

Title	See Page
<a href="#">Radar</a>	2-22
<a href="#">Automated Identification System (AIS)</a>	2-23

---

### Radar Beacons

#### C.1. Radar Beacons

RACON is an acronym for Radar Beacon. These beacons transmit a Morse Code reply when triggered by a boat’s radar signal. This reply “paints” the boat’s radar screen in the shape of dashes and dots representing a specific Morse Code letter, always beginning with a dash. The “paint” signal appears on the radar screen showing the Morse Code signal beginning at a point just beyond the location of the RACON transmitter location and extending radially for one to two nautical miles.

Transmission characteristics of RACONs may be found in the appropriate *Light List*. RACONs are shown on nautical charts with the letters “RACON” and a circle. RACONs are especially useful when trying to distinguish navigation aids from other contacts in congested areas. They can be found on both buoys and fixed structures.

---



## Automated Identification System (AIS)

### C.2. Automated Identification System (AIS) AtoN

The Automated Identification System (AIS) is an internationally adopted radio communication protocol that enables the autonomous and continuous exchange of navigation safety related messages amongst vessels, lifeboats, aircraft, shore stations, and aids to navigation. AIS equipped aids and stations broadcast their presence, identity (9-digit Marine Mobile Service Identity (MMSI) number), position, and status at least every three minutes or as needed. All three AIS AtoN variants can be received by any existing AIS mobile device, but they would require an external system for their portrayal (i.e., ECDIS, ECS, radar, PC). **Table 2-2** provides amplifying information AIS AtoN electronic charting symbols now in use.

How they are portrayed currently varies by manufacturer, but the future intention is for the portrayal to be in accordance with forthcoming International Standards

There are numerous applications of virtual aids to navigation. They are used not only to mark specific locations like beacons or buoys do, but also to mark lines, areas and other forms. They are not intended to replace physical aids to navigation, but to complement or supplement existing marks to improve the safety of navigation.

---

### C.3. Real and Synthetic AIS AtoN

A ‘Real’ AIS AtoN Station is a physical aid to navigation fitted with an AIS device.

For practical or economic reasons it may not be appropriate to fit an AIS to an AtoN. In this case, the ‘Synthetic’ AIS approach may be taken. There are two types of synthetic AIS AtoN, ‘Monitored’ and ‘Predicted’.

- (01) A ‘Monitored Synthetic AIS AtoN’ is transmitted from an AIS Station that is located remotely. The AtoN physically exists and there is a communication link between the AIS Station and the AtoN. The communication between the AtoN and AIS shall confirm the location and status of the AtoN.
- (02) A ‘Predicted Synthetic AIS AtoN’ is transmitted from an AIS Station that is located remotely. The AtoN physically exists but the AtoN is not monitored to confirm its location or status. Predicted Synthetic AIS AtoN should not be used for floating aids to navigation.

---

### C.4. Virtual AIS AtoN

A Virtual AIS AtoN is transmitted from an AIS station to establish an aid to navigation that does not physically exist. In this case, a digital information object will appear on the navigational system for a specified location, even though there is no physical AtoN. A nearby base station or AtoN station could broadcast this message. The AIS message will clearly identify this as a Virtual AIS AtoN.

---



**C.5. AIS AtoN  
Limitations**

A Virtual AtoN will not be visible on the displays of many ships and, if visible, the symbols may differ from one display to another. The consequences may be confusion, lack of information for the user and the undermining confidence in ECDIS, the chart and other systems.

Other limitations include:

- (01) GNSS vulnerability,
- (02) Susceptibility to spoofing and jamming.

Purpose of Virtual Aid	Definition	Electronic Chart Portrayal	Paper Chart Portrayal
North Cardinal	A virtual object that indicates navigable water lies northwards	 V-AIS	
East Cardinal	A virtual object that indicates navigable water lies eastwards	 V-AIS	
South Cardinal	A virtual object that indicates navigable water lies southwards	 V-AIS	
West Cardinal	A virtual object that indicates navigable water lies westwards	 V-AIS	
Port lateral (IALA A)	A virtual object marking the port side of a channel	 V-AIS	
Starboard Lateral (IALA A)	A virtual object marking the starboard side of a channel	 V-AIS	
Port lateral (IALA B)	A virtual object marking the port side of a channel	 V-AIS	
Starboard Lateral (IALA B)	A virtual object marking the starboard side of a channel	 V-AIS	
Isolated Danger	A virtual object marking an isolated danger	 V-AIS	
Safe Water	A virtual object marking safe water	 V-AIS	
Special Purpose	A virtual object used to mark an area or feature referred to in nautical documents	 V-AIS	
Emergency Wreck Marking	A virtual object marking a wreck	 V-AIS	

**Table 2-2  
AIS or Virtual Aids to Navigation (AtoN)**





**NOTE** 

The symbols used in the chart above are examples of virtual AtoN and there is no mandate for an international standard. Different electronic navigation systems may use different symbols.



---

## Section D. The Light List

---

**Introduction** The *Light List* is a seven-volume, annual publication providing information on AtoN maintained or authorized by the U.S. Coast Guard located on coastal and inland waters. The volumes cover the U.S. and its possessions, including the Intracoastal Waterway, Western Rivers, and the Great Lakes for both U.S. and Canadian waters. Each volume contains information on AtoN within its region maintained under the authority of the Coast Guard, including authorized private aids.

---

**D.1. Contents** This publication includes detailed descriptions of both short-range AtoN, radionavigation systems, and complete lists of lights for the area.

---

**D.2. Numbering Sequence** The aids in the *Light List* are listed so that seacoast aids appear first, followed by entrance and harbor aids from seaward to the head of navigation. *Light List* numbers (LLNR) are assigned to aids for easy reference and appear in sequence from:

- (01) North to south along the Atlantic Coast,
- (02) South to north and east to west along the Gulf Coast,
- (03) South to north along the Pacific Coast.

---

**D.3. General Information Section** The general information section offers information about the layout and organization of the *Light List*. It describes the U.S. system of AtoN and its characteristics and provides a glossary of terms.

---

**D.4. Example of Using the *Light List*** To determine the position and characteristic of Ocean City Inlet Jetty Light the following procedures should be taken to find this information in the *Light List*:

Step	Procedure
1	Use the <i>Light List</i> for that location (Volume II, Atlantic Coast).
2	Look up “Ocean City Inlet Jetty Light” in the index and note the LLNR ( <b>Table 2-3</b> ). In this example, the LLNR is “225.”
3	Find the correct page, listing LLNR 225 ( <b>Figure 2-10</b> ). Each AtoN is listed numerically by LLNR.
4	Extract the information needed for the aid.

In this case, the position of the light is 38°19.5' N, 75°05.1' W; and the light characteristic is Isophase white 6 seconds.

**NOTE**

In the index below, the Ocean City Inlet Jetty Light has what appear to be two LLNRs, 225 and 4720. Having two LLNRs means that this aid will be listed as a “seacoast” aid using LLNR 225, and again as a “harbor entrance” aid under Ocean City Inlet Jetty Light using LLNR 4720. Seacoast AtoN are indexed in the beginning of the *Light List*.



<b>O</b>	
Oak Creek .....	26205
Oak Island Channel.....	30415
Oak Island Light .....	810
Oak Island Radiobeacon .....	815
Occohannock Creek.....	21695
Occoquan River .....	18265
Ocean City Inlet.....	4720
OCEAN CITY INLET JETTY LIGHT ..	225
Ocean City Inlet Radiobeacon .....	230
<i>Ocean City Inlet Lighted Bell Buoy 2</i> .....	240
Ocean City Research Buoy .....	235
Ocean City Wreck Buoy WR2.....	245
OCEAN PINES YACHT CLUB .....	4925
Ocracoke Inlet.....	28895
Ocracoke Light .....	660

**Table 2-3**  
**Light List Index**

(1) No.	(2) Name and location	(3) Position	(4) Characteristic	(5) Height	(6) Range	(7) Structure	(8) Remarks
<b>SEACOAST (Maryland) – Fifth District</b>							
<b>OCEAN CITY INLET TO CAPE HATTERAS (Chart 12200)</b>							
225 4720	OCEAN CITY INLET JETTY LIGHT	38 19.5 75 05.1	<b>iso W 6<sup>s</sup></b>	28	8	NB on skeleton tower.	HORN: 1 blast ev 15 <sup>s</sup> (2 <sup>s</sup> bl).
230 4725	<b>Ocean City Inlet Radiobeacon</b>	38 19.5 75 05.3	<b>OC (--- ---•)</b>		10		FREQ: 293 kHz. Antenna located on Ocean City Inlet Jetty Light.
235	Ocean City Research Buoy	38 20.8 75 01.1				Yellow.	Maintained by U.S. Army Corps of Engineers.

**Figure 2-10**  
**Light List Excerpt**



**D.5. Example of  
Local Notice to  
Mariners Chart  
Corrections for  
AIS AtoNs**

<b>Chart Correction for <i>Real AIS ATON</i></b>					
12326	52nd Ed.	01-JUNE-13	Last LNM: 53/13	NAD 83	LNM/14
<i>Chart Title: Approaches to New York</i>					
	ADD	Magenta circle AIS Chart No. 1: S17.2 to ABC Channel Lighted Whistle Buoy A and		CGD 40-27-27.991N	073-50-12.228W
	CHANGE	Characteristic to RW "A" Mo (A) WHIS Racon (-) AIS			
 <b>Chart Correction for <i>Synthetic AIS ATON</i></b>					
18649	68th Ed.	01-JUNE-13	Last LNM: 52/13	NAD 83	LNM/14
<i>Chart Title: Entrance to San Francisco Bay</i>					
	ADD	Magenta circle AIS Chart No. 1: S17.2 to ABC Approach Lighted Whistle Buoy AB and		CGD 37-44-59.749N	122-41-33.940W
	CHANGE	Characteristic to RW "AB" Mo (A) WHIS Racon (-) AIS			
 <b>Chart Correction for <i>Virtual AIS ATON</i></b>					
12314	33rd Ed.	01-JUNE -12	Last LNM: 51/13	NAD 83	LNM/14
<i>Chart Title: Delaware River Philadelphia to Trenton</i>					
	ADD	ABC Railroad Bridge South Starboard V-AIS ATON Chart No. 1: S18.2		to CGD 39-58-55.059N	075-04-06.856W
	ADD	ABC Railroad Bridge South Port V-AIS ATON Chart No. 1: S18.2		to 38-58-55.803N	076-23-04.547W

**D.6. Corrections** Corrections to the *Light List* are made in the “Local Notice to Mariners” published by each Coast Guard district. These notices are essential for all navigators to keep their charts and *Light List*, current.

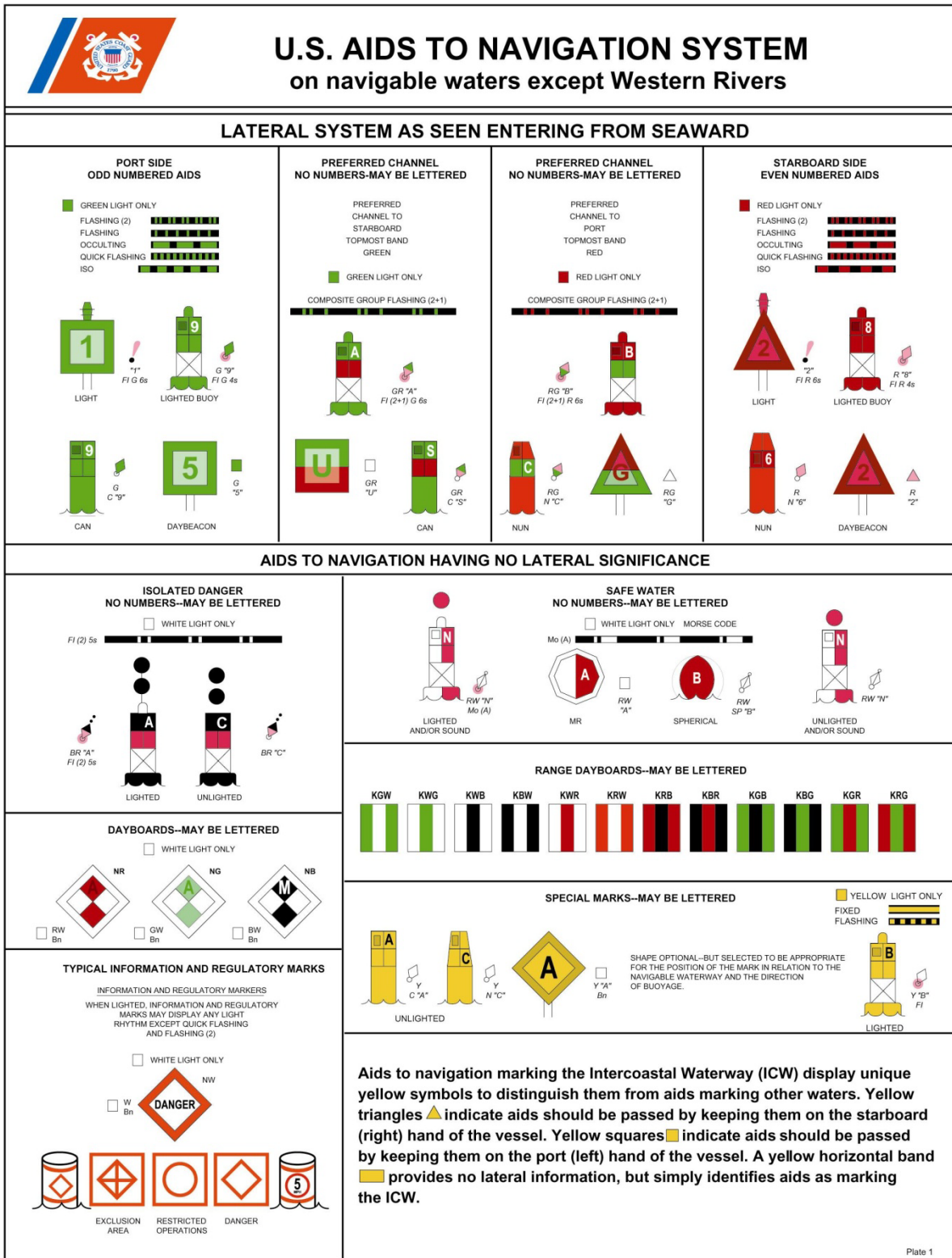

**Figure 2-11**  
 U.S. Aids to Navigation System on Navigable Waters, Except the Western River System

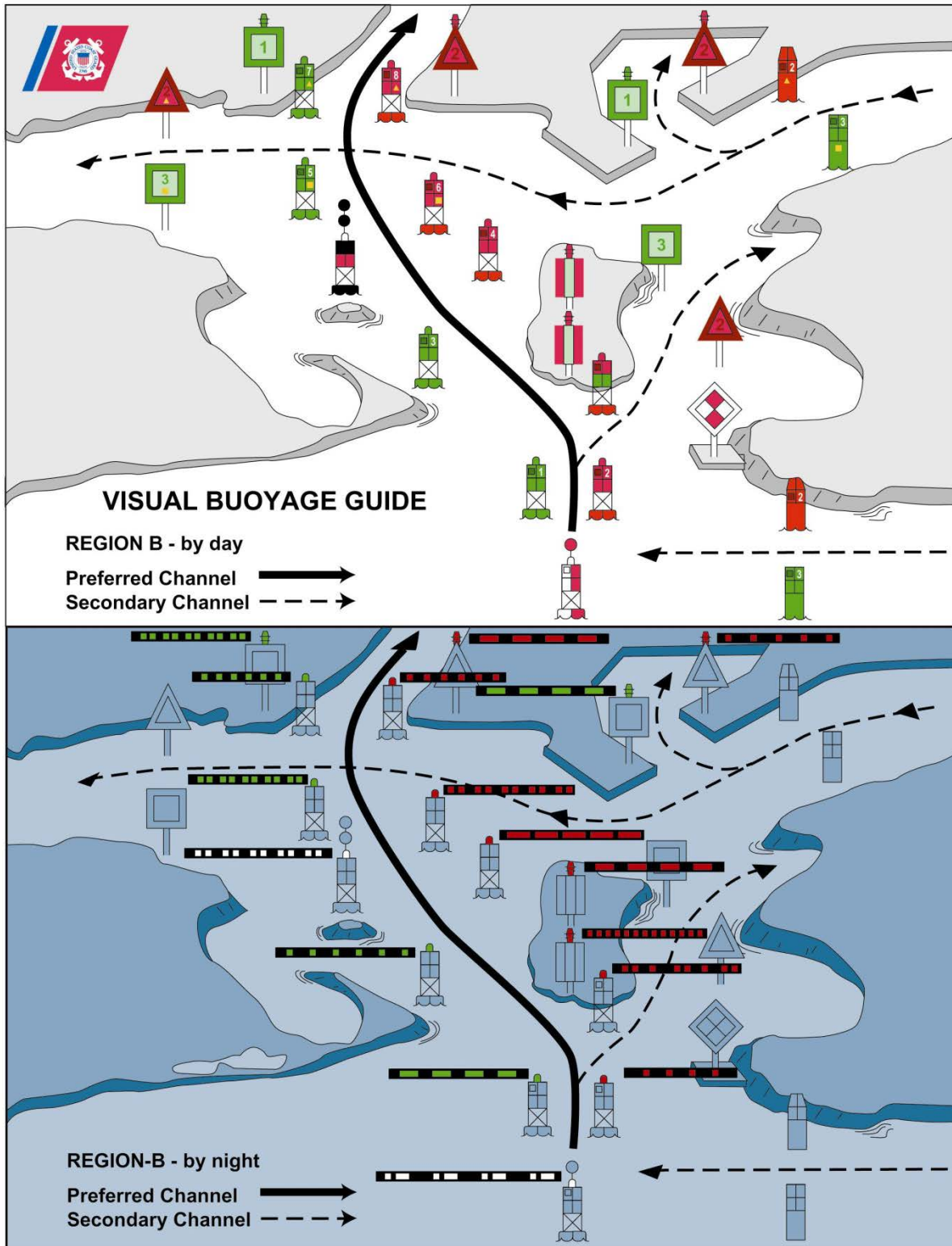
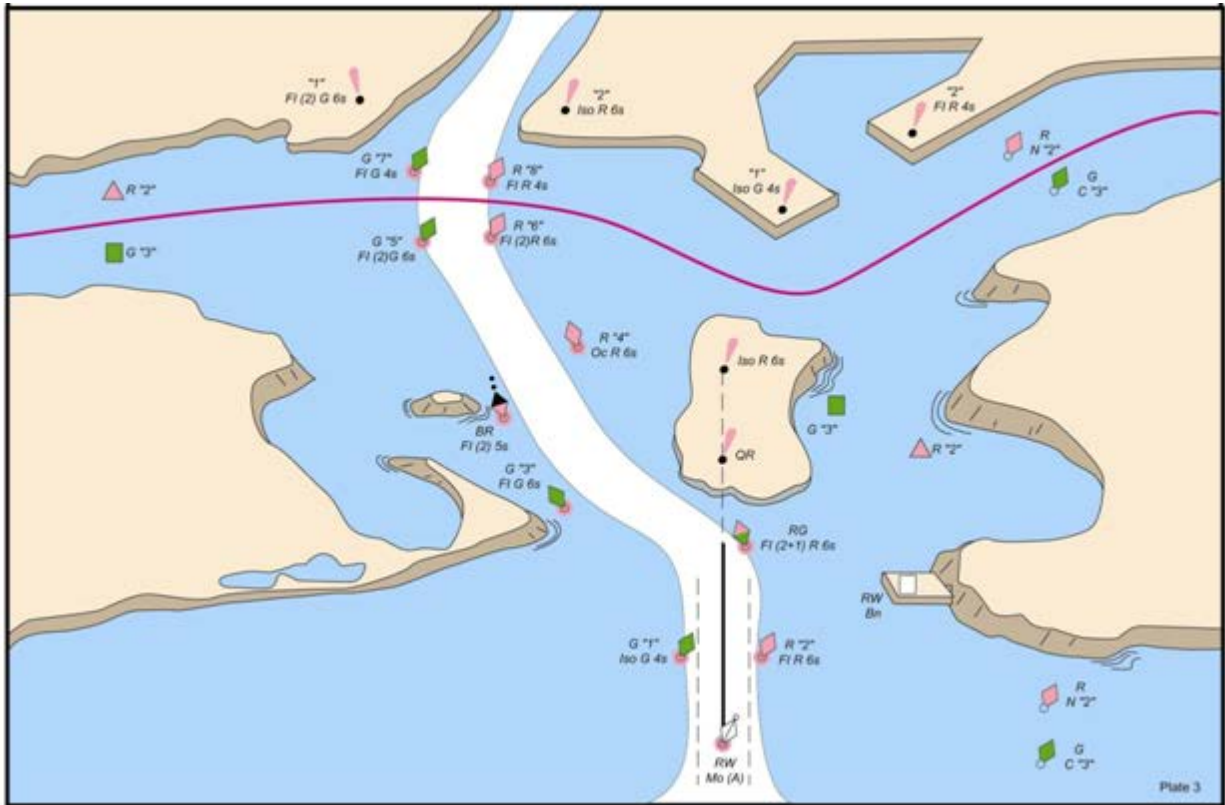

Figure 2-12  
Visual Buoyage Guide



**Figure 2-13**  
**How the Visual Guide Would Appear on a Nautical Chart (Example)**

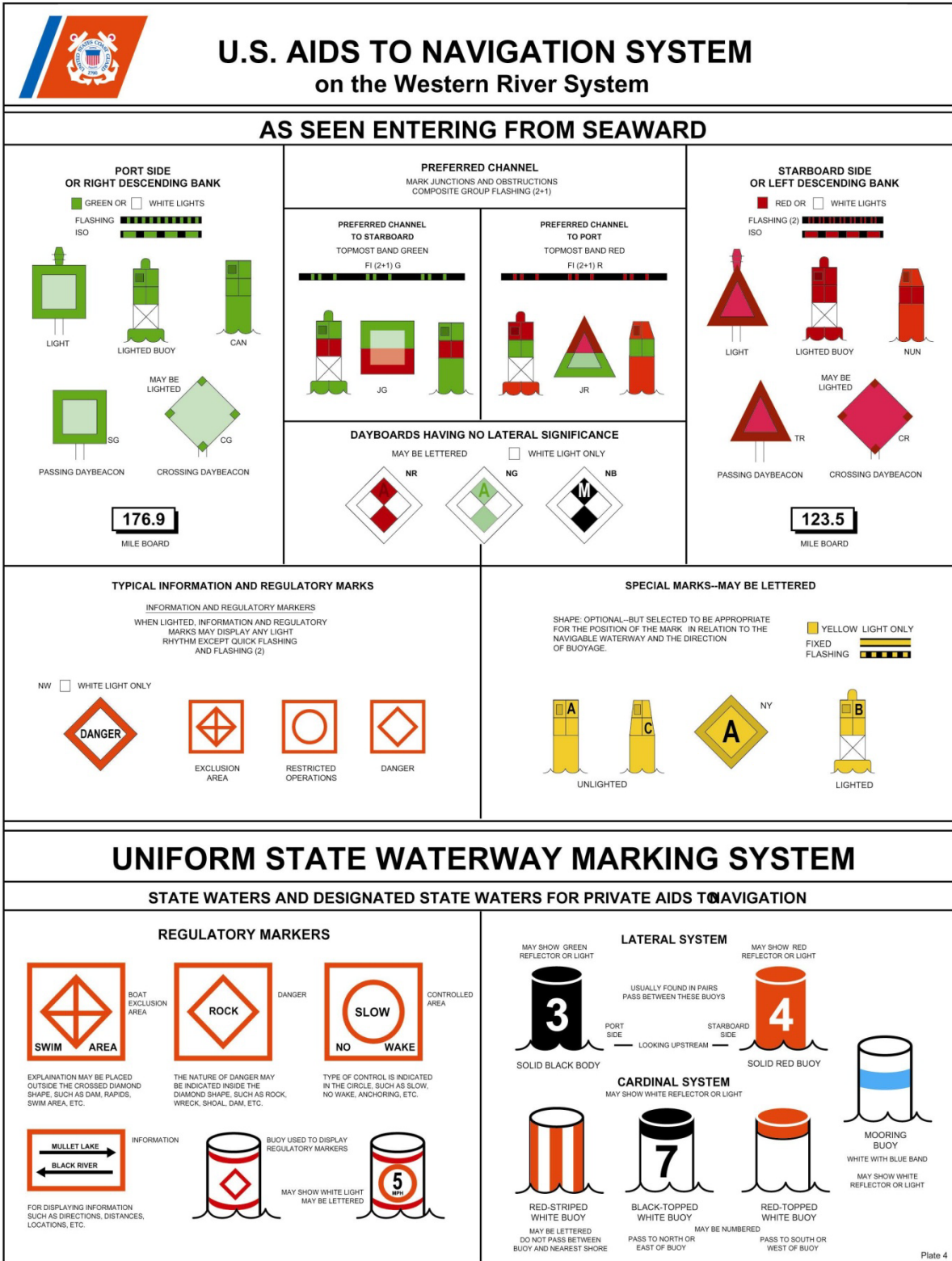

Plate 4

Figure 2-14

U.S. Aids to Navigation System on the Western River System and the Uniform State Waterway Marking System





## CHAPTER 3

### Navigation

#### Introduction

Navigation is the science and art of guiding a vessel from one location to another. From its inception mariners have relied on all available means to include: celestial bodies, currents, predictable winds, and landmarks. Navigation has since evolved to sophisticated and interconnected electronic systems. There is not one piece of equipment alone that can do the complete task of navigation, making it is necessary to collect and integrate information from all available sources.

The coxswain is responsible for knowing the position of the boat at all times. Additionally, the coxswain has been entrusted with the safety of the boat, all crewmembers, and completion of the mission or sortie.

A crewmember must learn all landmarks, charts and navigation aids used for the waters while operating. Through experience a crewmember will become proficient in the various skills necessary to perform any essential task in an emergency.

#### In this Chapter

This Chapter contains the following sections:

Section	Title	See Page
A	<a href="#">The Earth and Its Coordinates</a>	3-2
B	<a href="#">Nautical Charts</a>	3-8
C	<a href="#">Integrated Electronic Navigation Systems</a>	3-27
D	<a href="#">Direction</a>	3-51
E	<a href="#">Position</a>	3-78
F	<a href="#">Navigation Planning</a>	3-104
G	<a href="#">Piloting</a>	3-129
H	<a href="#">River Sailing</a>	3-148



---

## Section A. The Earth and Its Coordinates

---

### Introduction

Navigation is accomplished using a grid system of vertical and horizontal lines that cover the entire globe. The horizontal lines are called parallels of latitude. The vertical lines are called meridians of longitude. Intersecting a latitude line with a longitude line provides a coordinate or position.

### In this Section

This section contains the following information:

Title	See Page
<a href="#">Reference Lines of the Earth</a>	3-2
<a href="#">Great Circles</a>	3-3
<a href="#">Parallels</a>	3-4
<a href="#">Meridians</a>	3-5
<a href="#">Chart Projections</a>	3-5

### A.1. Reference Lines of the Earth

The earth rotates around an axis; this axis may be defined as a straight line drawn through the center of the earth. The axis line meets the surface of the earth at the North Pole and at the South Pole. To determine location, a system of reference lines, or grid, is placed on the surface of the earth as shown in [Figure 3-1](#). This figure reveals the difficulty a boat navigator faces - the earth is curved as a sphere but navigation is typically done on a flat chart with straight reference lines running top to bottom and left to right.



**Figure 3-1**  
**Earth with Reference Lines**



## A.2. Great Circles

A great circle is a geometric plane passing through the center of the earth, which divides the earth into two equal parts. A great circle always passes through the widest part of the earth. The equator is a great circle. All circles that pass through both the North and South Poles are great circles. The edge of a great circle conforms to the curvature of the earth, similar to seeing a circle when looking at a full moon.

### NOTE

The earth's circumference is approximately 21,600 nautical miles. Determine a degree of arc on the earth's surface by dividing the earth's circumference (in miles) by 360 degrees.

### A.2.a. Circle Properties

The outline of the moon also reveals another fact about great circles which is a property of all circles: each circle possesses 360° around its edge, which passes through a sphere, as to divide the sphere into two equal half-spheres. There are an infinite number of great circles on a sphere.

### A.2.b. Degrees

Great circles have 360° of arc. In every degree of arc in a circle, there are 60 minutes. Sixty (60) minutes is equal to 1° of arc, and 360° are equal to a complete circle. When degrees are written, the symbol (°) is used.

### A.2.c. Minutes

For every degree of arc, there are 60 minutes. When minutes of degrees are written, the symbol (') is used; 14 degrees and 15 minutes is written: 14°15'.

When written, minutes of degrees are always expressed as two digits. Zero through nine minutes are always preceded with a zero. Three minutes and zero minutes are written as 03' and 00' respectively.

### A.2.d. Seconds

For every minute of arc in a circle, there are 60 seconds of arc. Sixty (60) seconds is equal to one minute of arc, and 60 minutes is equal to 1° of arc.

For every minute of arc, there are 60 seconds. When seconds are written, the symbol (") is used; 24 degrees, 45 minutes, and 15 seconds is written: 24°45'15".

When seconds are written, they are always expressed as two digits. Zero through nine seconds are always preceded with a zero. Six seconds and zero seconds are written as 06" and 00" respectively.

Seconds may also be expressed in tenths of minutes; 10 minutes, 6 seconds (10'06") can be written as 10.1'.

The relationship of units of “arc” can be summarized as follows:

Circle =	360 degrees (°)
1 degree (°) =	60 minutes (')
1 minute (') =	60 seconds (")



### A.3. Parallels

Parallels are circles on the surface of the earth moving from the equator to the North or South Pole. They are parallel to the equator and known as parallels of latitude, or just latitude.

Parallels of equal latitude run in a west and east direction (left and right on a chart). They are measured in degrees, minutes, and seconds, in a north and south direction, from the equator. ( $0^\circ$  at the equator to  $90^\circ$  at each pole).

The North Pole is  $90^\circ$  north latitude, and the South Pole is  $90^\circ$  south latitude. The equator itself is a special parallel because it is also a great circle. One degree of latitude (arc) is equal to 60 nautical miles (NM) on the surface of the earth; one minute ( $'$ ) of latitude is equal to 1 NM. The circumference of the parallels decreases as they approach the poles (**Figure 3-2**).

On charts of the northern hemisphere, true north is usually located at the top. Parallels are normally indicated by lines running from side to side. Latitude scales, however, are normally indicated along the side margins by divisions along the black-and-white border.

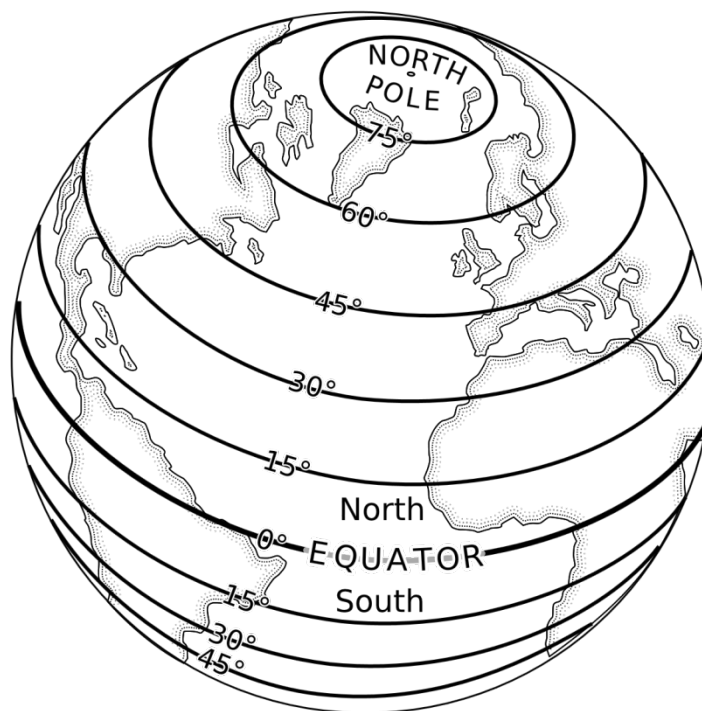

**Figure 3-2**  
Parallels of Latitude



#### A.4. Meridians

A meridian is a great circle formed by a plane, which cuts through the earth's axis and its poles. Such circles are termed meridians of longitude.

The meridian which passes through Greenwich, England, by international convention, has been selected as 000° and is called the Prime Meridian. From this point, longitude is measured both east and west for 180°.

The 180° meridian is on the exact opposite side of the earth from the 000° meridian. The International Date Line generally conforms to the 180th meridian. The great circle of the Prime Meridian and the International Date Line divide the earth into eastern and western hemispheres.

A degree of longitude equals 60 miles only at the equator and is undefined at the poles since all meridians meet there at one point. Meridians of Longitude run in a north and south direction (top to bottom on a chart) and are measured in degrees, minutes, and seconds, in an east or west direction (**Figure 3-3**).

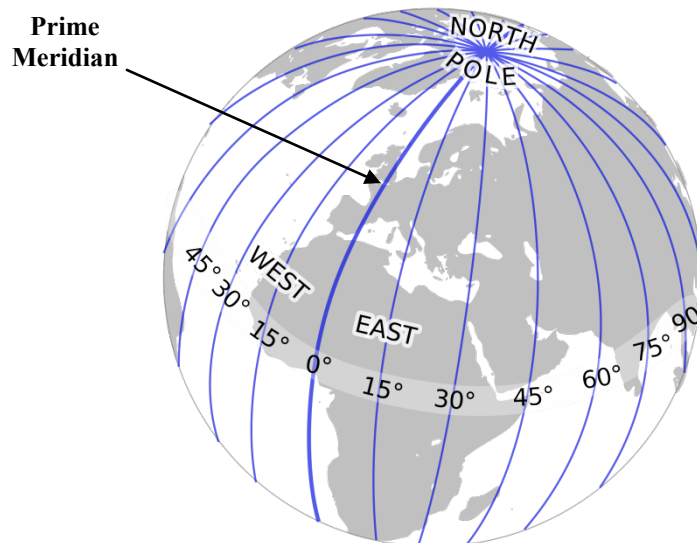

**Figure 3-3**  
Meridians of Longitude

#### A.5. Chart Projections

To represent the features of the earth's spherical surface on the flat surface of a chart, a process termed "projection" is used. The nautical chart will show features such as shorelines, depth of water, aids to navigation and other navigational information. It is a work area that the boat crews use to fix the position of the vessel and plot courses.

Two basic types of projection (**Figure 3-3**) used in making piloting charts are:

- (01) Mercator.
- (02) Gnomonic.

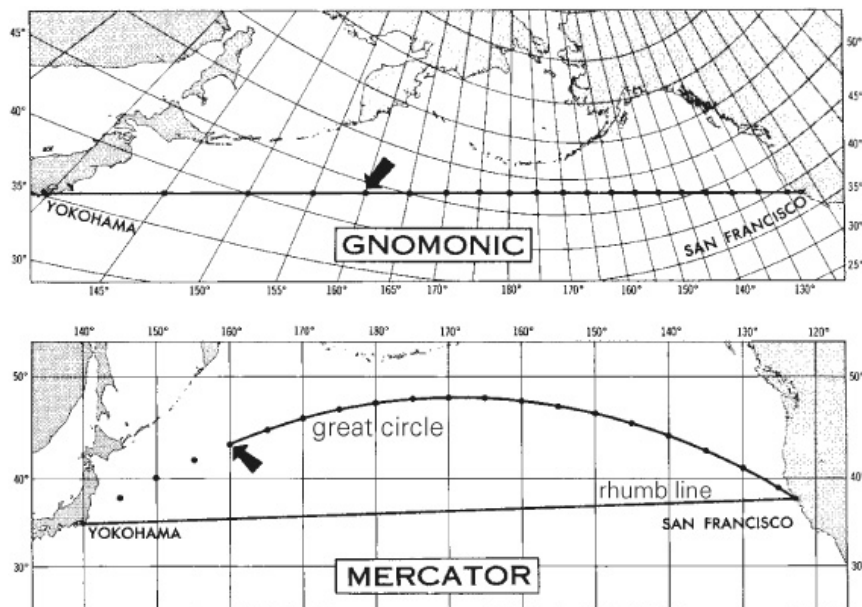

**Figure 3-4**  
**Chart Projections**

---

**A.5.a. Mercator Projection**

Mercator charts are the primary charts used aboard boats. A Mercator projection is made by transferring the surface of the globe (representing the earth) onto a cylinder. On a Mercator projection, the lines of longitude are straight with vertical lines equal distance apart at all latitudes. The horizontal distances are stretched above and below the Equator, with the stretching exaggerated near the poles.

The Equator, when represented on a Mercator chart, is the only true representation of an actual scale of the Earth. When sailing toward the poles, the actual distances between the meridians start to close in and get closer together.

---

**A.5.a.1. Rhumb Line**

Boat navigation is generally accomplished by plotting rhumb lines on a Mercator chart. A rhumb line is an imaginary line that intersects all meridians at the same angle. The rhumb line on the surface of a sphere is a curved line. On most Mercator charts, this curved line (rhumb) is represented as a straight line.

A course line, such as a compass course, is a rhumb line that appears as a straight line on a Mercator chart. Navigating with a rhumb line course allows the helmsman to steer a single compass course.

---



A.5.b.  
Gnomonic  
Projection

Gnomonic projections aid in long distance navigation by allowing navigators to use great circle courses. Meridians appear as straight lines that converge as they near the closest pole. The equator is represented by a straight line; all other parallels appear as curved lines.

The conventional way to identify a position on the globe is to write the latitude first, and then the longitude, each followed by its corresponding hemisphere.

The (N) north and (W) west in the example (**Figure 3-3**) below identify the hemisphere.

A.5.c.  
Hemispheres

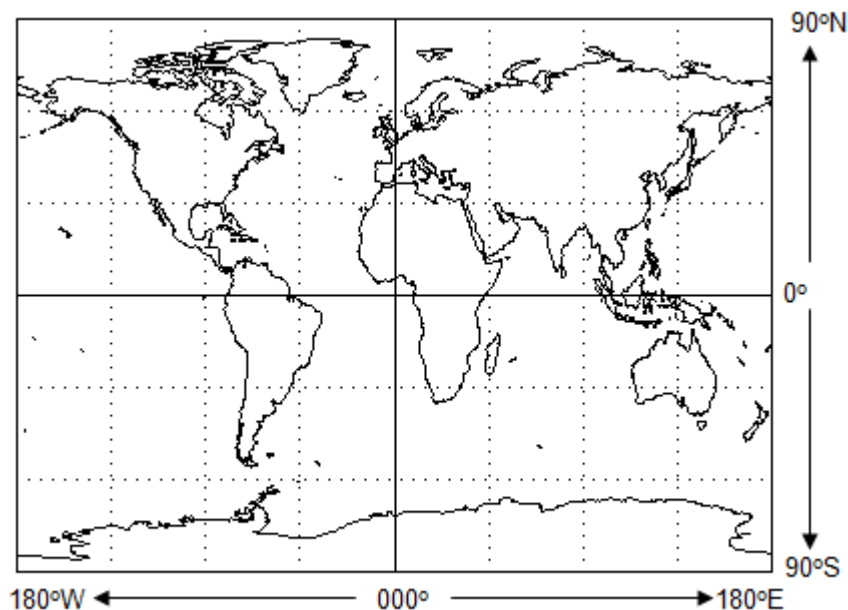

**Figure 3-5**  
**Earth's Four Hemispheres**

Latitude (Lat) and longitude (Long) positions can be reported in three ways. Although written differently these numbers mark the exact same position.

- (01) Degrees, minutes, seconds: 40° 26' 46" N, 79° 58' 56" W
- (02) Degrees, minutes, tenths of minutes: 40° 26.767' N, 79° 58.933' W
- (03) Decimal degrees: 40.446° N 79.982° W

Most GPS units present the latitude (lat) and longitude (long) readings in degrees, and minutes, and tenths of minutes.

Examples:

- (04) 37° 29.30' is latitude is thirty seven degrees, twenty nine decimal three-zero minutes.
- (05) 075° 29.35' is longitude is zero seven six degrees, twenty nine decimal three five minutes.



---

## Section B. Nautical Charts

---

**Introduction** The nautical chart is one of the mariner’s most useful and most widely used navigational aids. Navigational charts contain a lot of information of great value to you as a boat coxswain.

**In this Section** This section contains the following information:

Title	See Page
<a href="#">Direction and Depth</a>	3-8
<a href="#">Information and Symbols</a>	3-10
<a href="#">Chart Accuracy</a>	3-23
<a href="#">Electronic Charts</a>	3-25

---

### Direction and Depth

**B.1. Compass Rose** Nautical charts usually have one or more compass roses printed on them. These are similar in appearance to the compass card and, like the compass card, are oriented with north at the top. Directions on the chart are measured by using the compass rose ([Figure 3-6](#)). Direction is measured as a straight line from the center point of the circle to a number on the compass rose. Plotting the direction and explanation of the terms is discussed later. There are three main parts of a compass rose; outer ring (true north), inner ring (magnetic north) and variation.

---

**Figure 3-6**  
**Compass Rose**





---

B.1.a Outer Ring The outer ring of the compass rose is true north. True north is the direction along the earth’s surface towards the geographical north pole.

---

B.1.b Inner Ring Magnetic direction is printed around the inside of the compass rose. An arrow points to magnetic north. Magnetic north is the direction in which a compass would point if it were not subjected to any local disturbing effect.

---

B.1.c Variation Variation, the difference between true and magnetic north for the particular area covered by the chart, is printed in the middle of the compass rose (as well as any annual change).

---

**B.2. Soundings** One of the more vital services a chart performs is to describe the bottom characteristics to a boat operator. This is accomplished through the use of combinations of numbers, color codes, underwater contour lines, and a system of symbols and abbreviations.

---

B.2.a Datum The nautical chart water depth is measured downward from sea level at low water (soundings). Heights or landmarks are given in feet above sea level. In the interest of navigation safety, the mean, or average, of the lower of the two tides in the tidal cycle is used for soundings.

---

B.2.b. Mean Low Tide Most of the numbers on the chart represent soundings of the water depth at mean low tide. Datum refers to a base line from which a chart’s vertical measurements are made.

---

B.2.c. Mean Low Water “Mean low water” is a tidal datum that is the average of all the low water heights observed over the National Tidal Datum Epoch (19 year average).

---

B.2.d. Average Low Tide Since the greatest danger to navigation is during low tide, a number of the depths of low tide are averaged to produce the average low tide.

---

B.2.e. Mean Lower Low Water “Mean lower low water” is a tidal datum that is the average of the lowest low water height of each tidal day observed over the National Tidal Datum Epoch (19 year average).

---

**CAUTION!**

Mean Tidal range is an average depth of water over a period of time. Actual depth may be lower or higher depending on the tide.

---

B.2.f. Color Code Generally, shallow water is tinted darker blue on a chart, while deeper water is tinted light blue or white.

---



B.2.g. Contour  
Lines

Contour lines, also called fathom curves, connect points of roughly equal depth and provide a profile of the bottom. These lines are either numbered or coded, according to depth, using particular combinations of dots and dashes. Depth of water may be charted in feet, meters or fathoms (a fathom equals six feet). The chart legend will indicate which unit (feet, meters or fathoms) is used.

---

## Information and Symbols

### B.3. Basic Chart Information

The nautical chart shows channels, depth of water buoys, lights, lighthouses, prominent landmarks, rocks, reefs, sandbars, and much more useful information for the safe piloting of the boat. The chart is the most essential part of all piloting equipment. Below are some basic facts to know about charts:

- (01) Most charts are oriented with north at the top.
- (02) The frame of reference for all chart construction is the system of latitude and longitude.
- (03) Any location on a chart can be expressed in terms of latitude or longitude (**Figure 3-7**):
  - a) The latitude scale runs along both sides of the chart.
  - b) The longitude scale runs across the top and bottom of the chart.
  - c) Latitude lines are reference points in a north and south direction with the equator as their zero reference point.
  - d) Longitude lines are the east and west reference points with the prime meridian as their zero reference point.

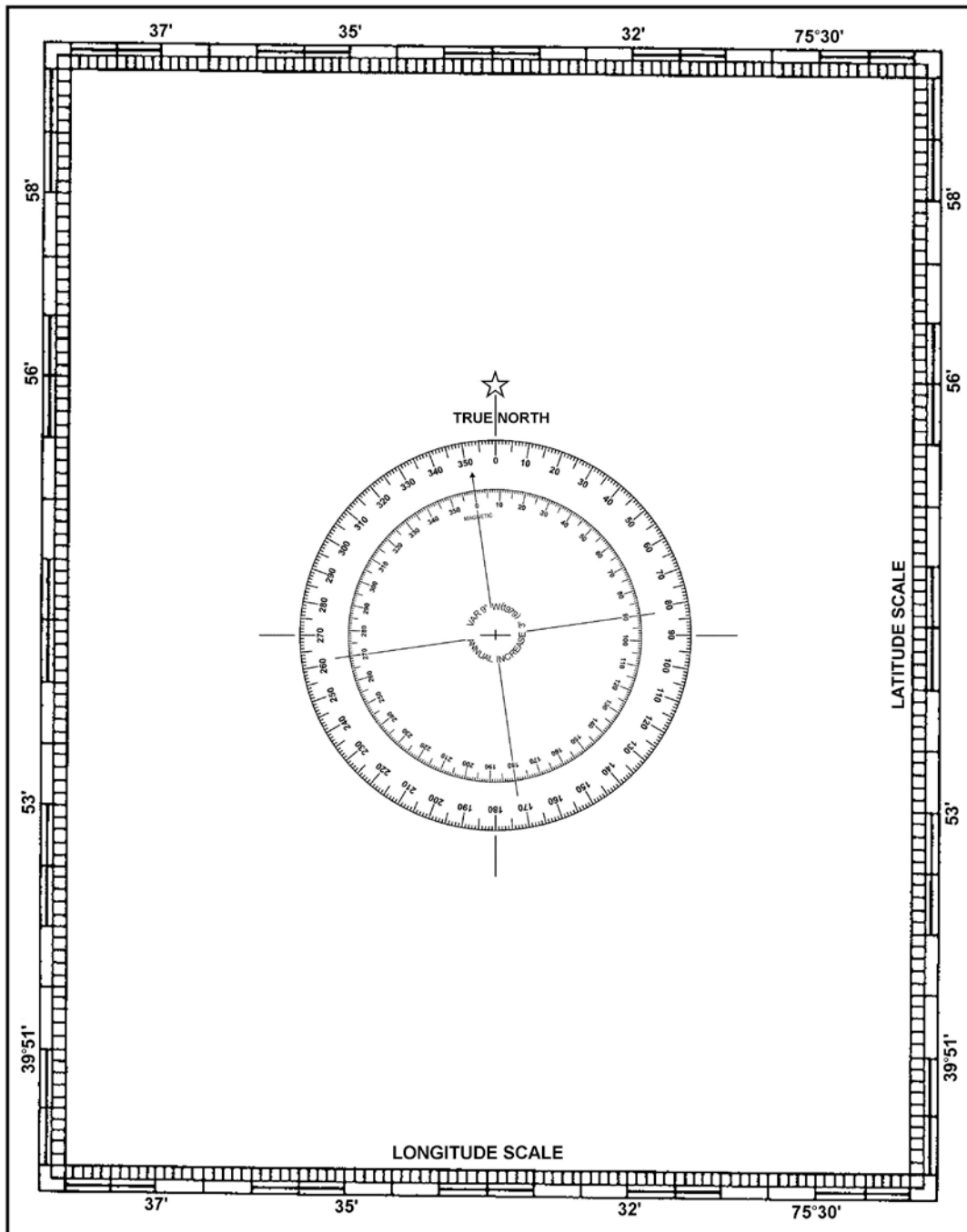

Figure 3-7  
Chart Orientation



B.3.a. Title Block

The general information block (see **Figure 3-8**) contains the following items:

- (01) The chart title which is usually the name of the prominent navigable body of water within the area covered in the chart.
- (02) A statement of the type of projection and the scale.
- (03) The unit of depth measurement, listed as soundings (feet, meters or fathoms).

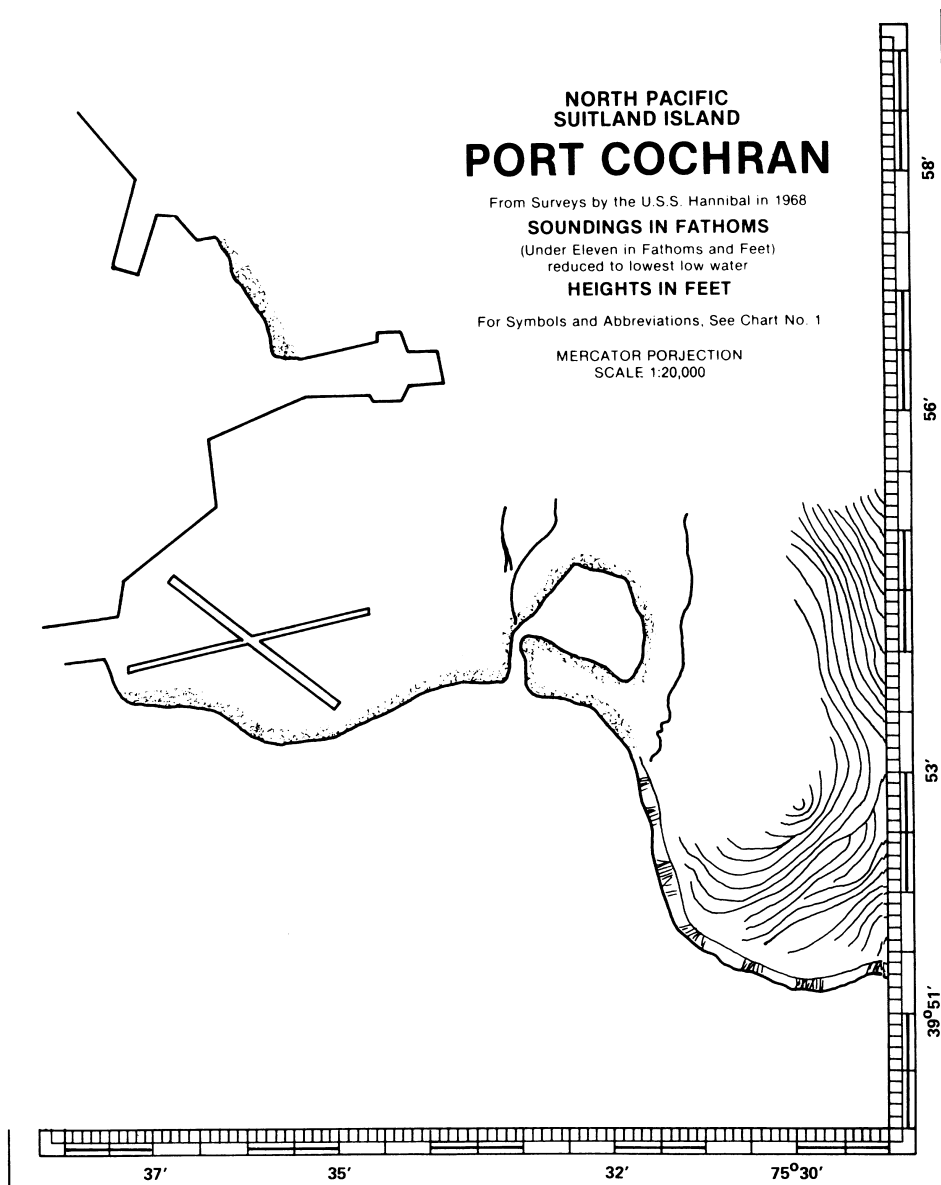

**Figure 3-8**  
Title Block of a Chart



---

**B.3.b. Notes**

Notes are found in various places on the chart, such as along the margins or on the face of the chart. They may contain information that cannot be presented graphically, such as:

- (01) The meaning of abbreviations used on the chart.
- (02) Special notes of caution regarding danger.
- (03) Tidal information.
- (04) Reference to anchorage areas.

---

**B.3.c. Edition Number**

The edition number of a chart and latest revisions indicate when information on the chart was updated.

- (01) The edition number and date of the chart is located in the margin of the lower left hand corner.
- (02) The latest revision date immediately follows in the lower left hand corner below the border of the chart. Charts show all essential corrections concerning lights, beacons, buoys and dangers that have been received to the date of issue.

Corrections occurring after the date of issue are published in the Notice to Mariners and must be entered by hand on the chart of your local area upon receipt of the notice.

---

**B.4. Chart Scale**

The scale of a nautical chart is the ratio comparing a unit of distance on the chart to the actual distance on the surface of the earth.

For example: The scale of 1:5,000,000 means that one of some kind of measurement of the chart is equal to 5,000,000 of the same kind of measurement on the earth's surface. One inch on the chart would equal 5,000,000 inches on the earth's surface. This would be a small scale, chart, since the ratio 1/5,000,000 is a very small number.

A large scale chart represents a smaller area than that of a small scale chart. There is no firm separation between large scale and small scale.

**NOTE** 

Remember large scale - small area, and small scale - large area.

For example: The scale of 1:2,500 (one inch on chart equals 2,500 inches on the earth's surface) is a much larger number and is referred to as a large scale chart.

**NOTE** 

Navigate with the largest scale chart available.



---

**B.4.a. Sailing  
Charts**

Sailing charts are produced at scales of 1:600,000 and smaller. They are used in fixing the mariners position for approach to the coast, from the open ocean, or for sailing between distant coastal ports.

On such charts, the shoreline and topography are generalized. Only offshore soundings, such as the principal lights, outer buoys and landmarks visible at considerable distances are shown.

---

**B.4.b. General  
Charts**

General charts are produced at scales between 1:150,000 and 1:600,000. They are used for coastwise navigation outside of outlying reefs and shoals when the ship or boat is generally within sight of land or AtoN and its course can be directed by piloting techniques.

---

**B.4.c. Coastal  
Charts**

Coastal charts are produced at scales between 1:50,000 and 1:150,000. They are used for inshore navigation, for entering bays and harbors of considerable width, and for navigating large inland waterways.

---

**B.4.d. Harbor  
Charts**

Harbor charts are produced at scales larger than 1:50,000. They are used in harbors, anchorage areas, and the smaller waterways.

---

**B.4.e. Small  
Craft Charts**

Small craft charts are produced at scales of 1:40,000 and larger. There are special charts of inland waters, including the intracoastal waterways. Special editions of conventional charts, called small craft charts, are printed on lighter weight paper than a normal chart and folded.

These “SC” charts contain additional information of interest to small craft operators, such as data on facilities, tide predictions, and weather broadcast information.

---

**B.5. Chart  
Symbols &  
Abbreviations**

Many symbols and abbreviations are used on charts. It is a quick way to determine the physical characteristics of the charted area and information on AtoN.

These symbols are uniform and standardized, but may vary depending on the scale of the chart or chart series. These standardized chart symbols and abbreviations are shown in the Pamphlet ‘Chart No. 1’; published jointly by the National Oceanic and Atmospheric Administration and National Geospatial-Intelligence Agency.

---



---

**B.5.a. Color** Nearly all charts employ color to distinguish various categories of information such as shoal water, deepwater, and land areas. Color is also used with AtoN to make them easier to locate and interpret.

Nautical purple ink (magenta) is used for most information since it is easier to read under red light normally used for navigating at night.

---

**B.5.b. Lettering** Lettering on a chart provides valuable information. Slanted lettering on the chart is used to label all information that is affected by tidal change or current (with the exception of bottom soundings). All descriptive lettering for floating AtoN is found in slanted lettering.

Vertical lettering on the chart is used to label all information that is not affected by the tidal changes or current. Fixed aids such as lighthouses and ranges are found in vertical lettering (see **Figure 3-9**).

---

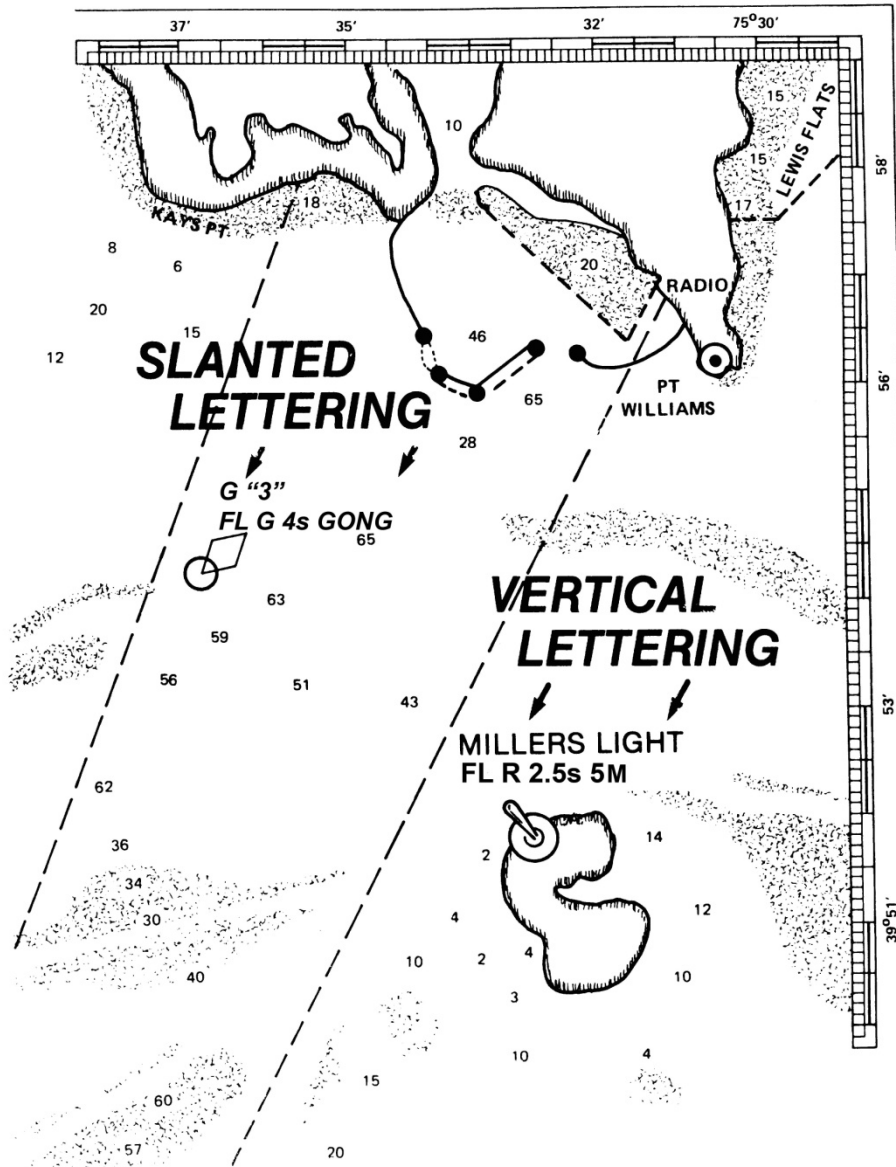

Figure 3-9  
Chart Lettering





---

B.5.c. Buoy  
Symbols

Buoys are shown with the following symbols:

- (01) The basic symbol for a buoy is a diamond and small circle.
- (02) A dot will be shown instead of the circle on older charts.
- (03) The diamond may be above, below or alongside the circle or dot.
- (04) The small circle or dot denotes the approximate position of the buoy mooring.
- (05) The diamond is used to draw attention to the position of the circle or dot and to describe the aid.

See **Figure 2-11** for additional information and color pictures of AtoN.

---

B.5.d.  
Lighthouses and  
Other Fixed  
Lights

The basic symbol for a light is a black dot with a magenta “flare” giving much the appearance of a large exclamation mark (!). Major lights are named and described; minor lights are described only.

---

B.5.e. Ranges

Ranges are indicated on charts by symbols for the lights (if lighted) and dashed line indicating the direction of the range.

---

B.5.f.  
Daybeacons

Daybeacons are indicated by small triangles or squares, which may be colored to match the aid. Daybeacons, also commonly called day marks, are always fixed aids. That is, they are on a structure secured to the bottom or on the shore. They are of many different shapes.

---



B.5.g. Prominent Landmarks

Prominent landmarks, such as water towers, smoke stacks, and flagpoles, are pinpointed by a standard symbol of a dot surrounded by a circle. A notation next to the symbol defines the landmark's nature. The omission of the dot indicates the location of the landmark is only an approximation (**Figure 3-10**).

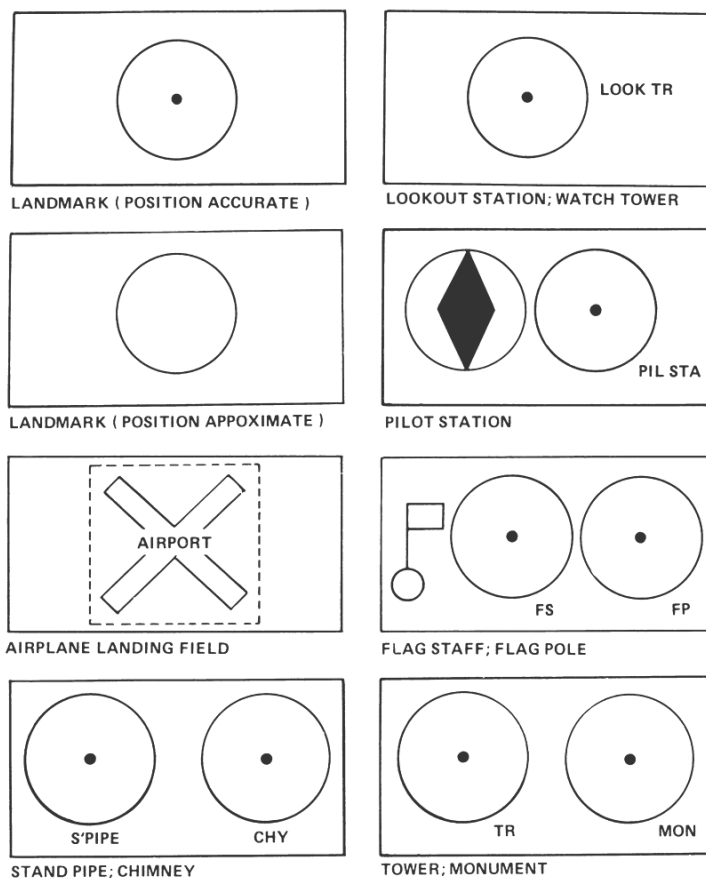

**Figure 3-10**  
**Symbols for Prominent Landmarks**



B.5.g. Wrecks, Rocks, and Reefs

These are marked with standardized symbols, for example, a sunken wreck may be shown either by a symbol or by an abbreviation plus a number that gives the wreck's depth at mean low or lower low water. A dotted line around any symbol calls special attention to its hazardous nature (**Figure 3-11**).

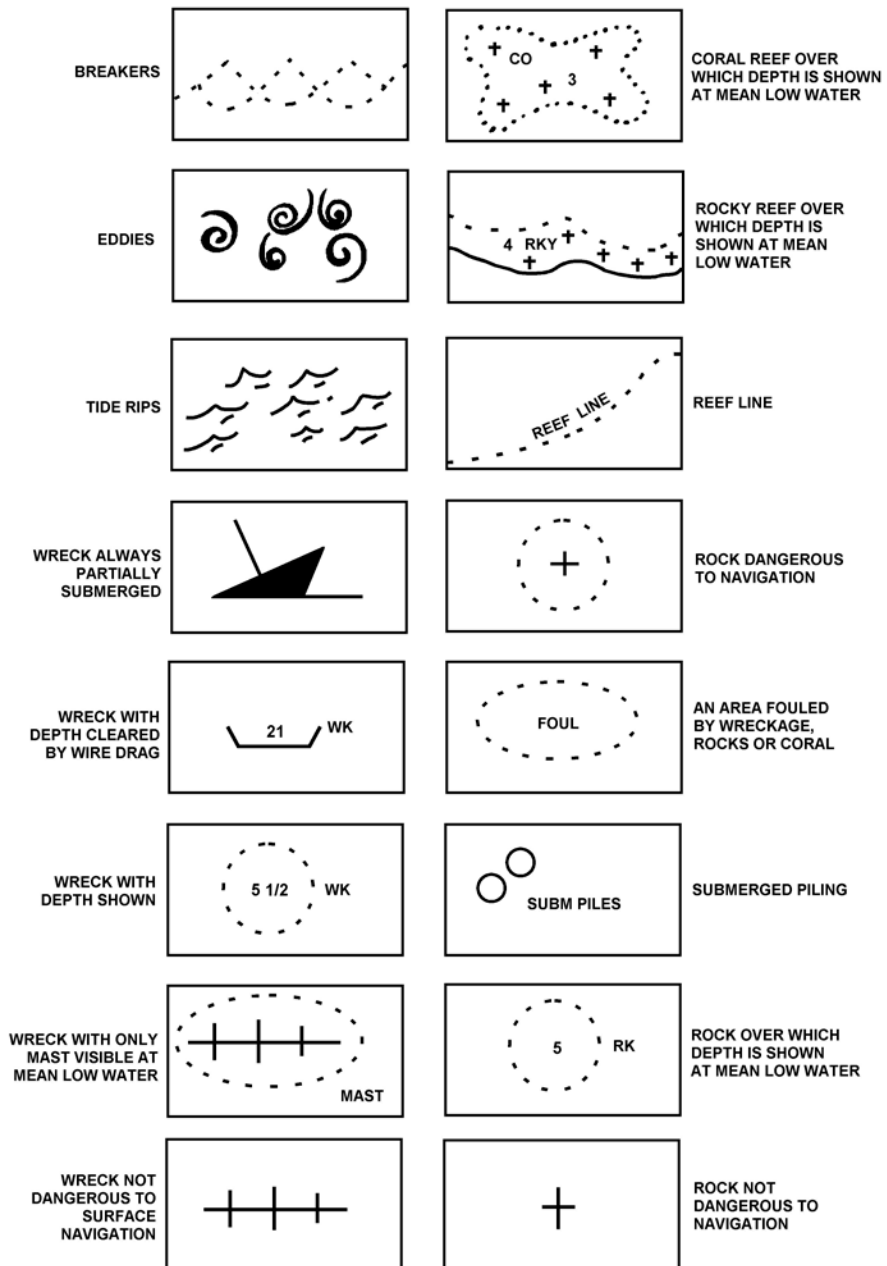

Figure 3-11  
 Symbols for Wrecks, Rocks, and Reefs



B.5.h. Bottom Characteristics

A system of abbreviations, used alone or in combination, describes the composition of the bottom allowing selection of the best holding ground for anchoring (**Table 3-1**).

**NOTE** 

Knowledge of bottom quality is very important in determining an anchorage.

Abbreviation	Composition	Abbreviation	Composition
hrd	Hard	M	Mud; Muddy
Sft	Soft	G	Gravel
S	Sand	Stk	Sticky
Cl	Clay	Br	Brown
St	Stone	Gy	Gray
Co	Coral	Wd	Seaweed
Co Hd	Coral Head	Grs	Grass
Sh	Shells	Oys	Oysters

**Table 3-1**  
**Bottom Composition**



B.5.i . Structures Shorthand representations have been developed and standardized for low-lying structures such as jetties, docks, drawbridges, and waterfront ramps. Such symbols are drawn to scale and viewed from overhead (Figure 3-12).

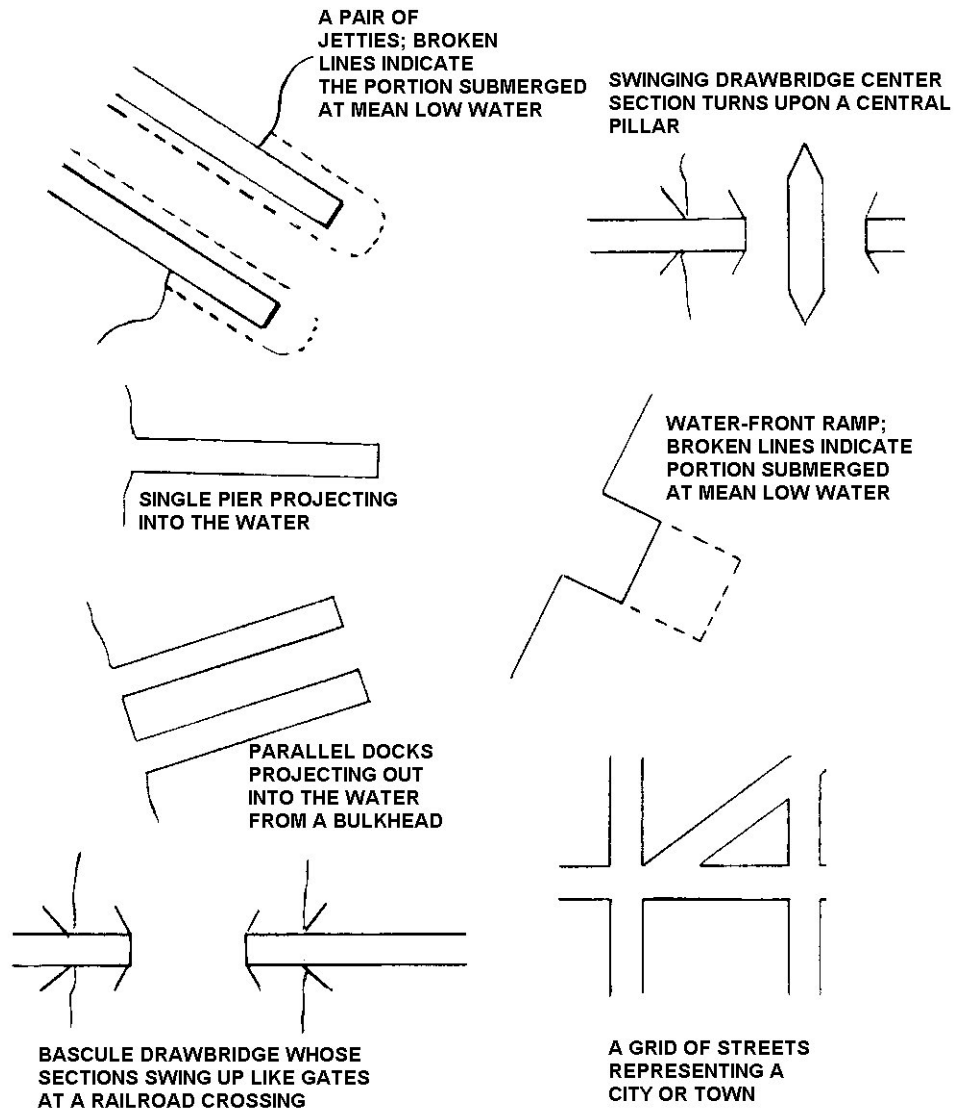
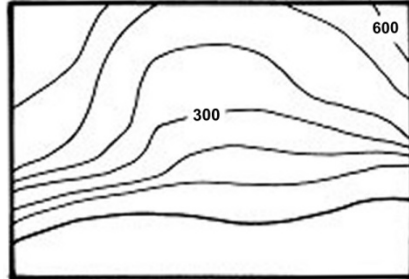

Figure 3-12  
Structures



B.5.j. Coastlines

Coastlines are viewed at both low and high water. Landmarks that may help in fixing position are noted and labeled (**Figure 3-13**).



COASTAL HILLS; CONTOURED LINES INDICATE ELEVATIONS.

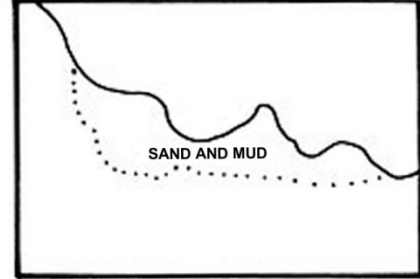

SAND AND MUD FLATS, THAT ARE EXPOSED AT MEAN LOW WATER.

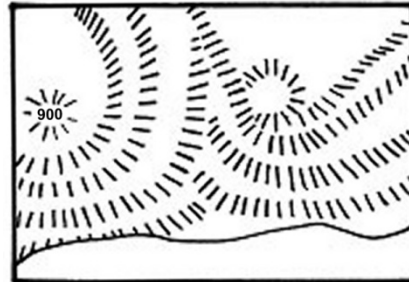

STEEP INCLINED COASTLINE; HACHURES (HATCH MARKS) ARE DRAWN IN THE DIRECTION OF THE SLOPES.

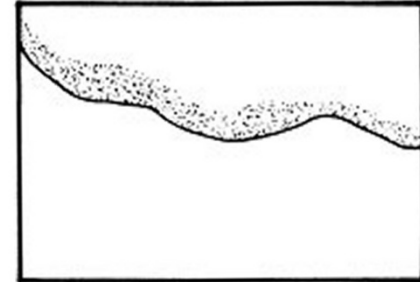

SANDY SHORE, THAT IS EXPOSED AT MEAN LOW WATER.

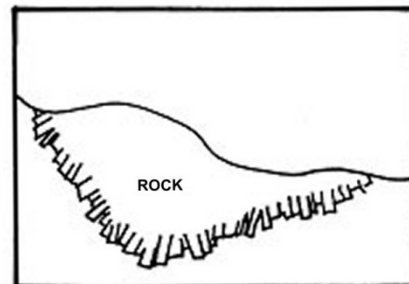

ROCK SHELF; UNCOVERS AT MEAN LOW WATER.

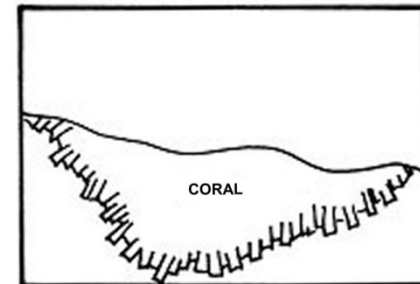

CORAL SHELF; UNCOVERS AT MEAN LOW WATER.

Figure 3-13  
Coastlines



## Chart Accuracy

**B.6. Accuracy of Charts** A chart is only as accurate as the survey on which it is based. Major disturbances, such as hurricanes and earthquakes, cause sudden and extensive changes in the bottom contour. Even everyday forces of wind and waves cause changes in channels and shoals. The prudent sailor must be alert to the possibilities of changes in conditions and inaccuracies of charted information.

---

**B.6.a. Determining Accuracy** Compromise is sometimes necessary in chart production as various factors may prevent the presentation of all data that has been collected for a given area. The information shown must be presented so that it can be understood with ease and certainty.

In order to judge the accuracy and completeness of a survey, the following should be noted:

- (01) Source and date.
  - (02) Testing.
  - (03) Full or sparse soundings.
  - (04) Blank spaces among sounding.
- 

**B.6.b. Source and Date** The source and date of the chart are generally given in the title along with the changes that have taken place since the date of the survey. The earlier surveys often were made under circumstances that precluded great accuracy of detail.

---

**B.6.c. Testing** Until a chart based on such a survey is tested, it should be regarded with caution. Except in well-frequented waters, few surveys have been so thorough as to make certain that all dangers have been found.

---



#### B.6.d. Sounding Methods

- (01) **Lead and Line** was the only method of sounding until echo sounders came into use in about 1935; the hand lead continued for inshore work into the 1950s. A sounding with lead and line covered only the few centimetres actually struck by the lead and objects less than a yard away from each cast remained undetected.
- (02) **Vertical Echo Soundings** examine only a narrow strip immediately under the hull of the ship, and, even on a large-scale harbour chart, these strips can be as much as 60 yards apart.
- (03) **Sidescan Sonar** was introduced in about 1973, allowing the detection of shoals and wrecks lying between sounding lines. Although sidescan sonar has been employed extensively since its development, the large majority of charts in use are still based on older surveying methods. For these reasons, it is still quite possible to find uncharted rocks, shoals and wrecks anywhere.

#### B.6.e. Full or Sparse Soundings

Noting the fullness or scantiness of the soundings is another method of estimating the completeness of the survey, but it must be remembered that the chart seldom shows all soundings that were obtained. If the soundings are sparse or unevenly distributed, it should be taken for granted, as a precautionary measure, that the survey was not in great detail.

Large or irregular blank spaces among soundings mean that no soundings were obtained in those areas. Where the nearby soundings are deep, it may logically be assumed that in the blanks the water is also deep. When the surrounding water is shallow, or if the local charts show that reefs are present in the area, such blanks should be regarded with suspicion. This is especially true in coral areas and off rocky coasts. These areas should be given wide berth.





## Electronic Charts

### B.7. Electronic Chart Types

There are two general types of electronic chart data: vector and raster. See reference (b) for more detailed information concerning electronic chart data and updates.

- (01) **Vector Charts.** These charts include Electronic Navigation Charts (ENC), Inland Electronic Navigation Charts (IENC), and Digital Nautical Charts (DNC). Vector charts consist of points, lines, and area data that represent real world objects. Since each object is separate, it allows for more information than can be displayed for each object to be stored in the chart data, allowing the user to query the chart. It also allows the navigation system to test each object for grounding or height alarms. Based on zoom level and operator preference the charting system can hide or display certain vector chart objects. System constantly display a set of base information, but the user must add other filters and objects to ensure safe navigation. The user can save these filters as part of the Profiles feature to ensure constant display of preferred objects.
- (02) **Raster Charts.** Raster charts (RNC) are digital images of paper charts. Each paper chart has a corresponding raster chart that is its digital equivalent. Users cannot query raster chart data for more information or use raster data for alarms. Over-scaling is readily apparent on a raster chart and accuracy is lost.

### NOTE

Commercial proprietary formats (e.g. Vega, C-MAP) present a unique appearance from RNC or ENC charts. Charting symbols vary by system and zoom will not afford denser data.

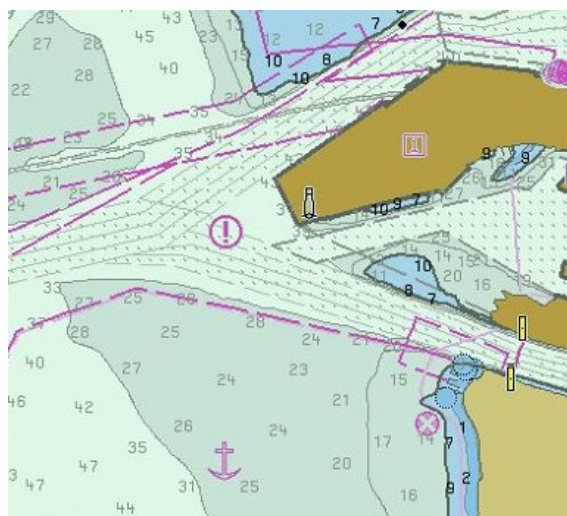

Figure 3-14  
Vector Chart (ENC)

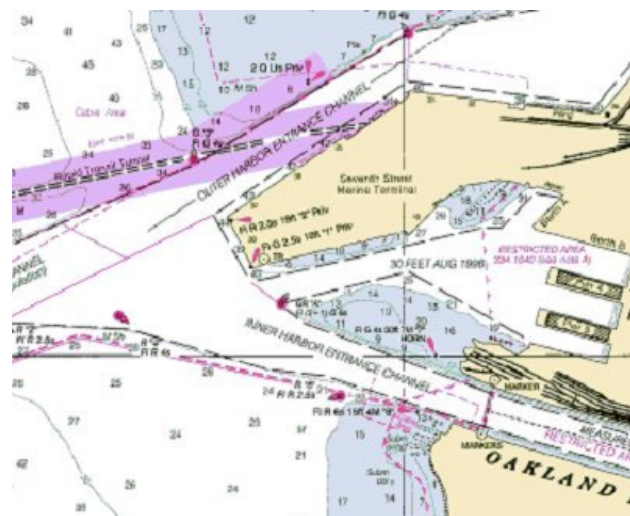

Figure 3-15  
Raster Chart (RNC)



B.7.a. AIS or  
Virtual Aids to  
Navigation

---

Addition information on Automated Identification Systems (AIS) is contained in Chapter 2, Section C, [Automated Identification System \(AIS\)](#).

---



---

## Section C. Integrated Electronic Navigation Systems

---

**Introduction** Electronic navigation systems automate the process of integrating real-time positions with a chart display, allowing immediate assessment of vessel position and surroundings. Electronic navigation systems also allow the integration of other operational data, such as ship's course and speed, depth soundings, and radar, into a single or multiple displays. Alarms from sensors and from chart data can warn of potentially dangerous situations well in advance.

---

**In this Section** This Section contains the following information:

Title	See Page
<a href="#">System Overview</a>	3-28
<a href="#">Specific Components</a>	3-29

---

**NOTE** 

Over-reliance on eNav systems can cause tunnel vision or ignorance of fundamental signs of danger. To prevent this, it is critical to understand system functions and use foundational navigation skills to properly prepare these systems and detect errors.

---



## System Overview

**C.1. Electronic Navigation** Coast Guard installed eNav systems vary in complexity and in their ability to mitigate navigational risk. System capabilities range from display of a GPS position on an approved electronic chart to systems that integrate onboard navigation sensors. Additionally, some Coast Guard eNav systems interface with external tactical systems, thereby providing a seamless navigational and operational situation display. See reference (b) for more detailed information.

---

**C.2. Interfacing** Marine instruments are most effective when working together to share and report information. In the early 1980s the National Marine Electronics Association (NMEA) devised a standard interface of language to allow products developed by different manufacturers to communicate. NMEA interfaces were originally designed for one-way communication between two instruments, but have advanced to allow a single instrument to send data to several others. For example a single GPS may provide information to an electronic chart plotter, a DSC radio, an autopilot, and other systems. These systems, in the event of an instrument failure are independent and will still function separately.

---



## Specific Components

### C.3. Multi-Function Displays

Electronic navigation systems are characterized by Multi Function Displays (MFD) that serve to present information from a variety of sources in a graphic format displayed on multiple screens (Figure 3-16). Capabilities of these systems vary widely, but all have similar characteristics in that they draw information from a variety of sources. Electronic chart plotters integrate radar and electronic navigational charts into their display (Figure 3-17).

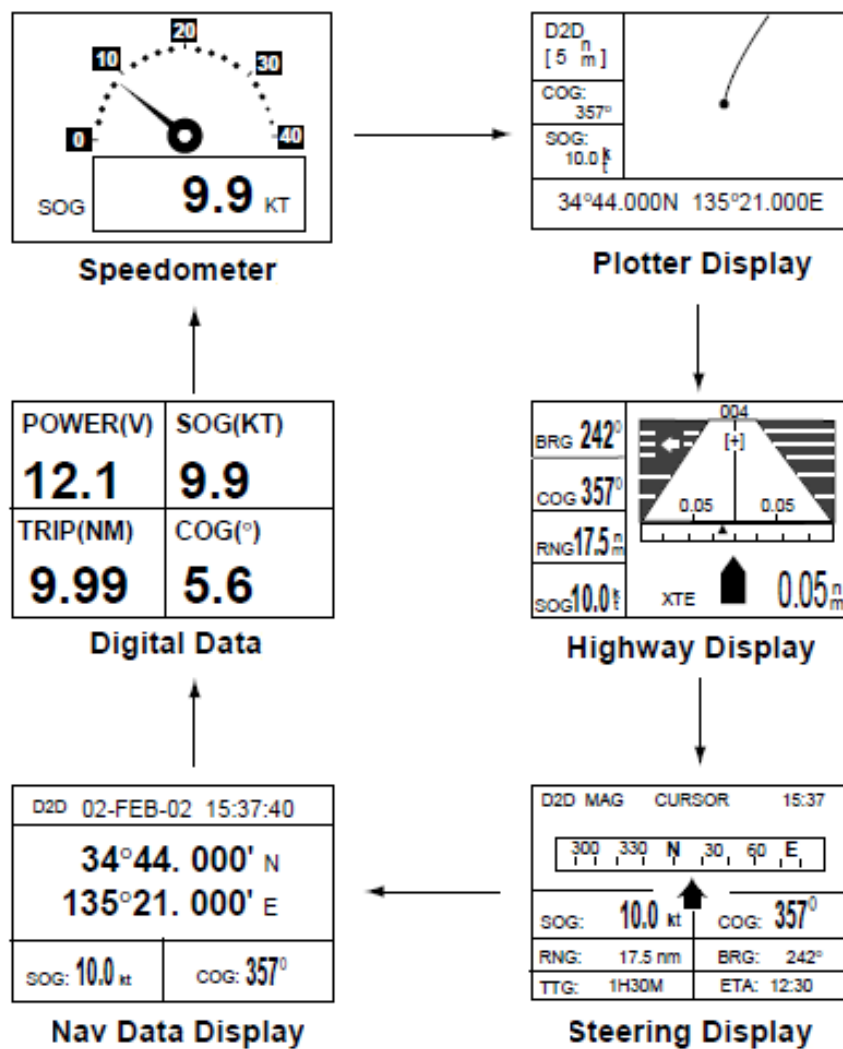

*Display modes*

Figure 3-16  
 Multi-Function Display Screens



**Figure 3-17**  
**Multi-Function Display / Electronic Chart Plotter (Example)**

#### **C.4. Electronic Chart Plotter**

Chart plotters are now a primary maritime navigation tool. In most case, they have all but replaced paper charts. They use electronic charts and are interfaced with GPS to allow for a rapid, reliable plot of the boat's position. Chart plotters allow you to see, from an electronic perspective, where your boat is, where you were (trackline history), and where you are heading. Additionally they can display a wide variety of data that the operator may find useful. The chart plotter becomes particularly useful when strict navigational tolerance is needed such as with low visibility situations or when transiting through hazardous areas. When combined with other electronics and sound navigation practices, safer navigation is possible. Features of these plotter systems include:

- (01) Know your current location at a quick glance
- (02) View your track history,
- (03) Show AtoN(Aids to Navigation), hazards, obstructions, wrecks, etc.,
- (04) Show water depth in a given location,
- (05) Store waypoints / routes (Including MOB),
- (06) Interface with GPS and autopilot for automatic steering,
- (07) Determine travel time (ETA),
- (08) View tide and current data(if equipped).



C.4.a. Electronic Chart Overlays

The MFD can incorporate a variety of data and display it in the form of overlays on the electronic chart. The availability of these overlays depends on whether the data is loaded onto the MFD or whether the devices that receive the data are active. Typical overlays include radar, satellite imagery, depth shading, tidal and current data, and weather.

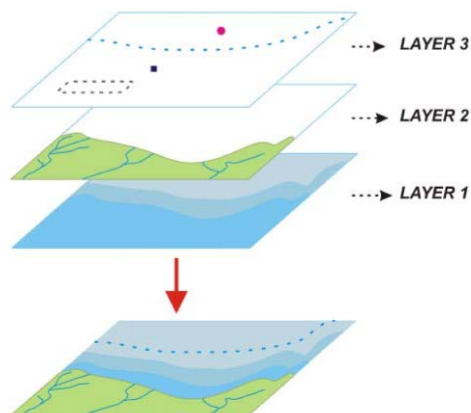

**Figure 3-18**  
**Electronic Chart Overlays**

C.4.b. Scaling

Electronic chart data is most accurate when displayed at its source scale. Scaling/zooming in or out distorts the visually perceived relative distance between chart objects. In addition, cursor-indicated positions for charted features vary when scaling the chart.

C.4.c. Display Matching

Display matching ensures displayed information is consistently oriented to the viewer, thereby preventing errors in interpretation. When the system displays radar and electronic chart data together in overlay mode, the display must match in scale, orientation, and projection. For example, scaling out the radar to 24 NM when the electronic chart scale is at 3 NM can cause misinterpretations.



#### C.4.d. Boat Position Symbol

Chart plotters display the boat's position as an icon. The heading line originates at the boat icon and continues to the edge of the screen. The course/speed vector indicator will appear as a separate line.

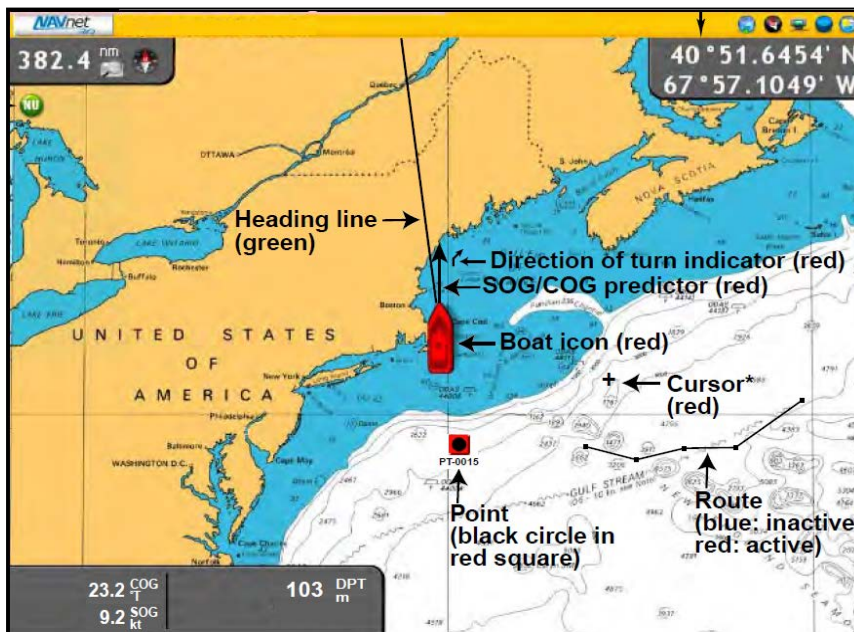

Figure 3-19  
Boat Position Symbol

#### C.4.e. Display Orientation

There are varying displays that can be configured, the crew must understand the differences and understand which display works best for them. Unless directed by your unit or parent command otherwise, there is no “correct” display orientation. These are usually considered personal preference. For example, someone may like north up because of their affinity to a paper chart, while others may like to see their course as it relates to the electronic chart. Take time to learn what your particular model has available and become comfortable with using them.

- (01) Course-Up – The course-up mode is preferred for monitoring your progress towards a waypoint. The destination is at the top of the screen when a destination is set. When no destination is set, the course or heading is at the top of the screen at the moment the course up mode is selected. If there is an auto-course feature, it will automatically adjust the screen to keep the course up pointing at the top of the screen. The adjustment is based on an arbitrary number of degrees and once exceeded it will rotate the screen to keep the course at the top of the screen. Some operators find this distracting when making large course changes as the screen tends to “change” a lot for some operators.





- (02) North-Up – North (000°) is always oriented at the top of the display screen. This mode is useful for navigation planning and when the boat is stationary. It can be helpful when executing a search pattern and determining course changes in relation to next turn and course. It is also beneficial when the operator is used to operating with a paper chart that is normally oriented with North at the top.

---

#### C.4.f .Tracks

In comparison to a route, a track is the path along which the boat travels and is plotted on the chart plotter with position data. The track function records where the boat has been and displays the path as a line on the electronic chart. Tracks can be shown if the information is helpful or necessary and can also be hidden if the data is no longer needed or clutters the chart.

---

#### C.4.g. Common Functions

While all systems are different, you should refer to your specific operator's manual for specific guidelines for operation, however, many share the same characteristics as follows:

- (01) Power / Brilliance – In general this button controls the power to the unit, either turning the plotter on and off or allowing the user to adjust the brilliance (how bright the display is).
  - (02) Range In/Out – The range is the distance that will be displayed on the screen. Common ranges for boat systems are from .125 NM to 24 NM or 48 NM. The area of operation will determine the best range to use. For example, if operating offshore the user may want to have the range set to 12 NM but when entering a harbor, a scale of 1.5 NM might be more appropriate. A smaller range usually includes more detail such as hazards, depths and AtoN.
  - (03) Center/Home – This brings the boat to the center of the screen.
  - (04) Offset –Allows for the boat icon to be moved from the center of the screen and placed at a specific location so other more relevant information can be shown. This may be advantageous when operating at higher speeds.
-



C.4.h. Navigation Data

Steering displays like the one below can be used to show navigational data when transiting to a waypoint. This tool displays information such as cross track error, heading, course over ground (COG), estimated time of arrival (ETA), and more.

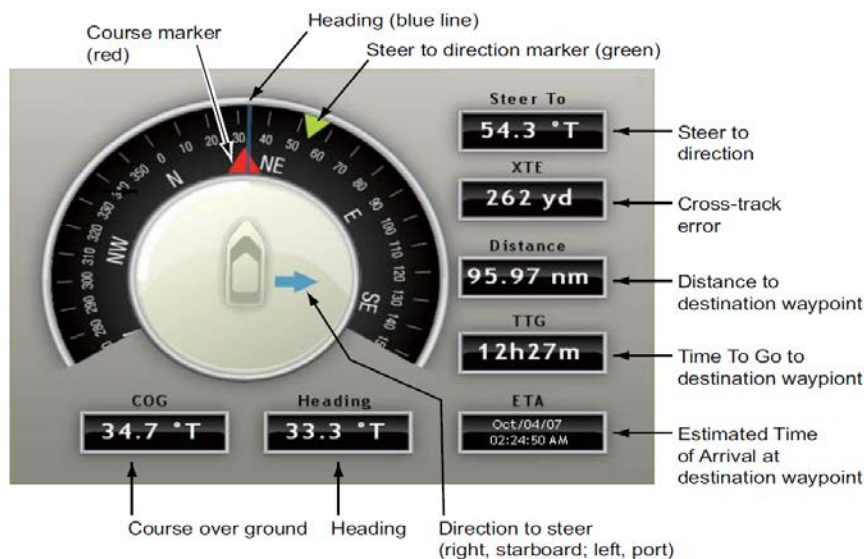

Figure 3-20  
Navigation Data

C.4.i. Data Boxes

When a route is active, navigation data boxes are displayed on the screen. These can be fully customized to display information such as distance-to-waypoint, course-to-steer, time-to-go, and cross track error.

C.4.j. Tidal Data

Many electronic chart plotters are equipped with tide and current information that can be accessed through menu options.

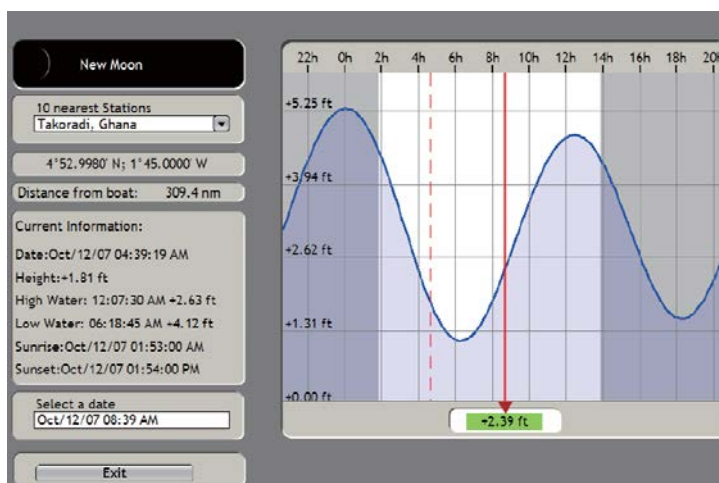

Figure 3-21  
Tidal Data



### C.5. Heading Sensor/Fluxgate Compass

Heading is the direction in which the vessel is pointing at any given moment. Electronic heading sensors have largely replaced the magnetic compass as the primary means of determining a vessel's heading, with the magnetic compass normally serving only as an emergency backup. An electronic heading sensor is installed on most modern boats and is normally mounted low on the centerline. The sensor detects terrestrial magnetism and produces heading data, which is utilized by electronic navigation system components that need accurate and stable heading input such as an electronic charting system and radar.

Heading accuracy of these sensors is typically  $\pm 1^\circ$ . Heading data is shown in three figure notation (ie.  $000^\circ$ ) and can be adjusted to display as either True or Magnetic, depending on user preference and standard operating procedures.

Though used by larger vessels, the gyrocompass will not be discussed since it is not commonly used by boats.

### C.6. Global Positioning System (GPS)

The Global Position System (GPS) is a radionavigation system of 24 satellites operated by the DoD. It is available 24 hours per day, worldwide, in all weather conditions. Each GPS satellite transmits its precise location, meaning position and elevation. In a process called "ranging," a GPS receiver on the boat uses the signal to determine the distance between it and the satellite. Once the receiver has computed the range for at least four satellites, it processes a three-dimensional position that is accurate to about 33 meters. GPS provides **two levels of service - SPS for civilian users, and PPS for military users.**



Figure 3-22  
GPS Screen



C.6.a. Selective Availability

GPS signals accessible to the general population have historically been deliberately degraded by the US government as it sought to retain the advantage of a more accurate signal. Termed selective availability, this intentional error ensured accuracy was no better than 100 meters 95% of the time. This system has been switched off, but may be reintroduced by the U.S. government without warning and at any time.

C.6.b. Differential Global Positioning System (DGPS)

DGPS employs a local fixed reference receiver to correct errors in standard GPS signals. These corrections are then broadcast from the reference receiver to any DGPS capable receiver. The corrections are applied within the user's receiver, providing mariners with a position that is accurate to within 3 meters, with 99.7% probability.

To receive DGPS signals the GPS receiver must be coupled with a DGPS receiver and be within range of a fixed reference station, normally 200 miles. DGPS was becoming common with general users until selective availability was turned off and GPS signals returned to their inherent 15 meter accuracy.

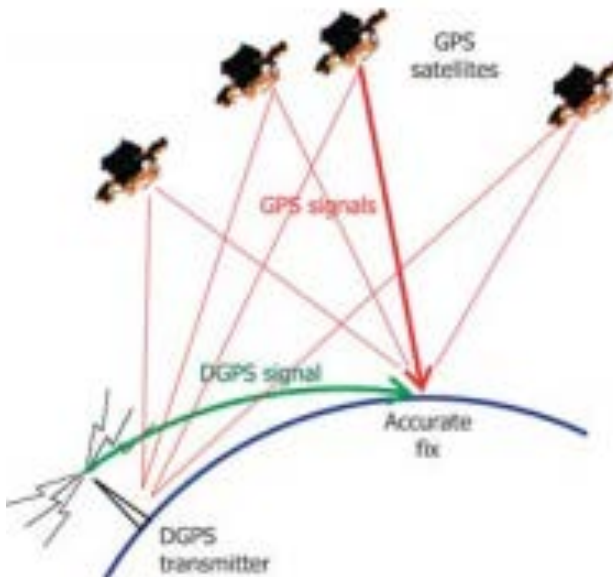

Figure 3-23  
Differential Global Positioning System (DGPS)



C.6.c. Wide Area Augmentation System (WAAS)

Wide Area Augmentation Service (WAAS) uses a network of ground stations to monitor accuracy of GPS positions. Error corrections are reported to two master stations which relay the data to the network of satellites for further distribution to all WAAS enabled GPS receivers. This process reduces the 95% error to an accuracy of approximately 3 meter.

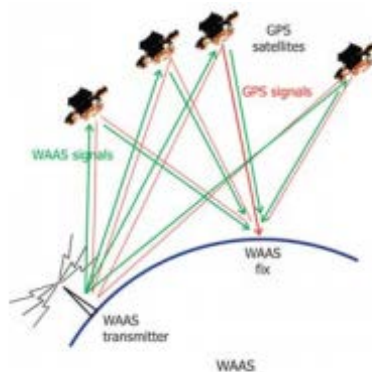

Figure 3-24  
Wide Area Augmentation System (WAAS)

C.6.d. Equipment Features

GPS receivers are small, have small antennas, and need little electrical power. Hand-held units are available. Positional information is shown on a liquid crystal display (LCD) screen as geographical coordinates (latitude and longitude readings). These receivers are designed to be interfaced with other devices such as autopilots, EPIRBs and other distress alerting devices, to automatically provide positional information.

Navigational features available in the typical GPS receiver include:

- (01) Entry of waypoints and routes in advance.
- (02) Display of course and speed made good.
- (03) Display of cross-track error.
- (04) Availability of highly accurate time information.

**NOTE** 

Over-reliance on eNav systems can cause tunnel vision or ignorance of fundamental signs of danger. To prevent this, it is critical to understand system functions and use foundational navigation skills to properly prepare these systems and detect errors.



### C.6.e. Signal Strength & Accuracy

The state of reception of GPS depends upon the strength of GPS signals. The greater the signal strength, the more stable the reception status is. State of reception depends upon the number of satellites tracked for positioning. If the number of the tracked satellites is great, GPS positioning becomes greater, but if there are fewer satellites tracked for positioning, it become difficult to generate a GPS position.

Determining GPS satellite signal strength at specific intervals is critical to ensuring displayed positioning data is accurate for navigation. (e.g. before getting underway and entering restricted waters, daily, etc). All navigation systems with GPS capability have a means for determining signal strength within their internal software (**Figure 3-25**). Consult the equipment’s manufacturer guidelines to determine how to access and review signal strength data.

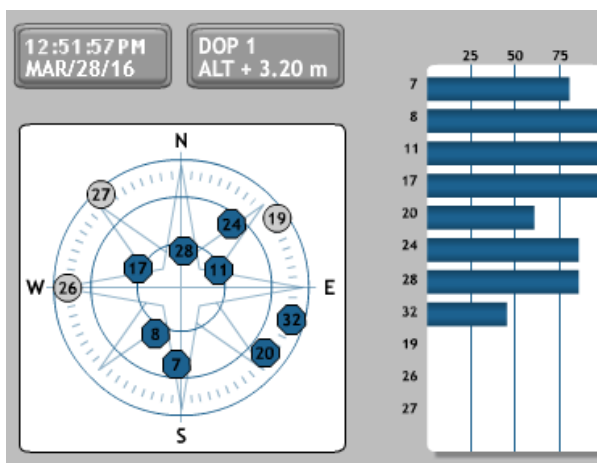

Figure 3-25  
GPS Signal Strength

When accessing signal strength data, GPS units generally provide the below information:

- (01) DOP (Dilution of Precision) describes the geometric strength of satellite configuration on GPS accuracy. When visible satellites are close together in the sky, the geometry is weak and the DOP value is high, when the satellites are far away from one another, the geometry is strong and the DOP value is low.
- (02) ALT is the height of your GPS antenna above the surface of the water.
- (03) Estimated position of each GPS satellite.
- (04) Satellites used to find position.
- (05) Satellites not used to find position.
- (06) The strength of the RX signal from each satellite is shown with a bar. If the signal level of a satellite is high, that satellite’s signal was used to find your position.



C.6.f. Read Latitude and Longitude

GPS units present latitude (Lat) and longitude (Long) readings in three ways:

- (01) Degrees, minutes, seconds: 40° 26' 46" N, 79° 58' 56" W,
- (02) Degrees, minutes, tenths of minutes: 40° 26.767' N, 79° 58.933' W,
- (03) Decimal degrees: 40.446° N 79.982° W.

C.6.g. Course Over Ground (COG)

Course over ground/course made good (COG/CMG), is direction of movement from one point to another with regard to wind and current.

C.6.h. Speed Over Ground (SOG)

Speed over ground (SOG), or Speed Made Good, is the speed of travel of a boat along the track, expressed in knots.

**C.7. Radar**

Radar uses radio waves to identify the location, course, and speed of objects. The center of the radar screen represents the position of the boat. When used properly, the radar enables you to identify land masses and other vessels, determine the distance from your vessel to contacts (range), and determine direction from your vessel to contacts, even in restricted visibility (bearing).

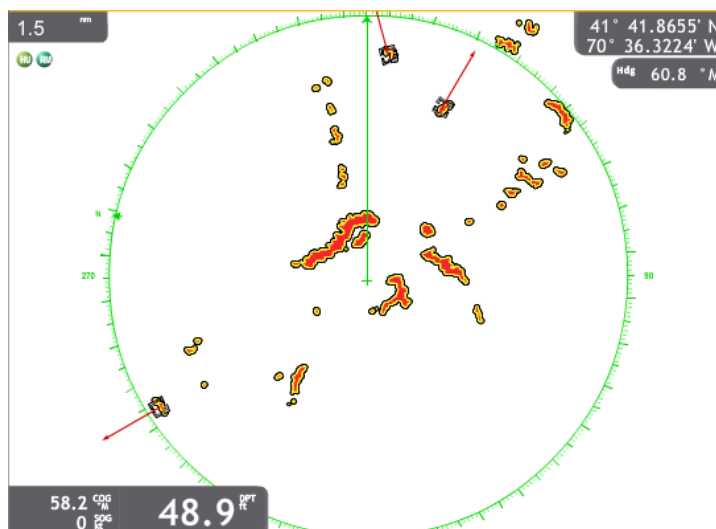

**Figure 3-26**  
**Radar**

A radar's pedestal transmits pulses of radio waves, then receives those wave that bounce off objects. The returns are processed and contacts are displayed on the radar screen in intensities according to echo strength. Images on a radar screen differ from what is seen visually by the naked eye. This is because some contacts reflect radio waves (radar beams) better than others. Familiarity with the operating area helps to identify images that are displayed. The radar does not paint a detailed picture of an object. Instead,



all objects displayed on the radar screen as indistinct masses of color. Knowing the location of land masses and man-made structures-such as bridges, docks, and navigational aids-helps differentiate those objects from other vessels on the radar.

C.7.a. Standby/  
Transmit

Often combined with the on/off button, the standby/transmit control switches the radar between a standby mode in which it is ready for use and transmit mode in which it is fully operational.

C.7.b. Gain

Gain on the radar is how well a contact or target appears. By increasing gain, the amount of echo returned is increased and the contact is seen much easier. If you adjust the gain too high however, excessive background noise can hide contacts from view. Conversely, the less gain, the less likely the contact will be seen. If you adjust the gain too low, objects with weak echoes do not display on the screen, increasing the risk of collision. The gain is set correctly when some background noise displays on the screen.

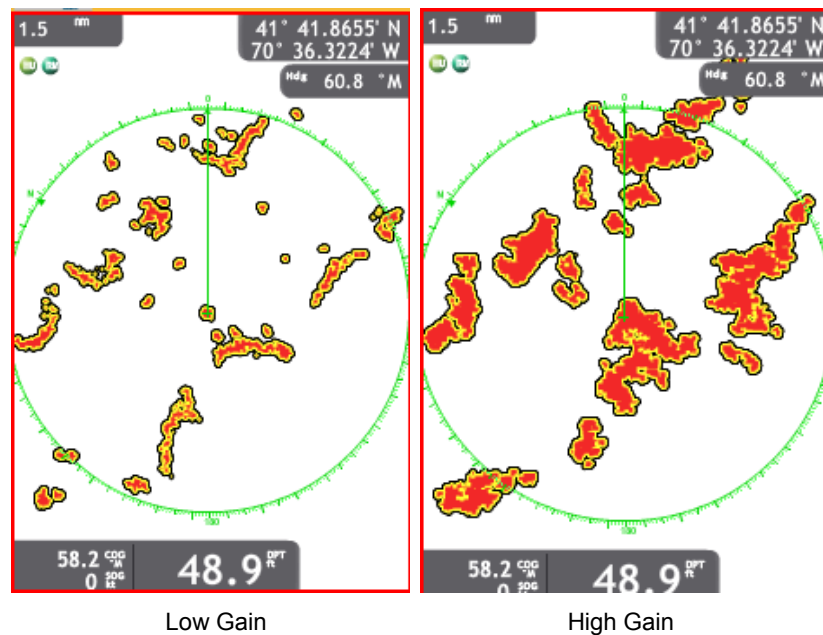

Figure 3-27  
Gain

C.7.c. Display  
Mode

- (01) **Head Up:** Available with no compass input as the heading mark points straight upwards. It has the advantage of displaying a target on the port side of the boat as a contact on the left side of the screen while those on the starboard side of the boat appear on the right hand side. The disadvantage is that, as the boat yaws, the picture yaws in response, causing the objects on the screen to move.





- (02) **North Up:** When provided heading information from an electronic or fluxgate compass a radar's picture can be rotated to put north at the top of the screen. This has the advantage that the picture is in the same orientation as a conventional navigational paper chart. It also stabilizes the picture
- (03) **Course Up:** The top of the screen represents the course of the boat.

---

C.7.d. Tuning      Older radar units needed to be tuned to get the best possible image, but modern systems automatically tune to the best possible settings. For additional information on tuning, consult the manufacturer guidelines for the radar in use.

---

C.7.e. Range      The minimum range is primarily established by the radio wave pulse length and recovery time. It depends on several factors such as excessive sea return, moisture in the air, other obstructions and the limiting features of the equipment itself. The minimum range varies but is usually 20 to 50 yards from the boat.

Maximum range is determined by transmitter power and receiver sensitivity. However, these radio waves are line of sight (travel in a straight line) and do not follow the curvature of the earth. Therefore, anything below the horizon will usually not be detected.

The useful operational range of a radar on a boat is limited mainly by the height of the antenna above the water.

---

C.7.f. Sea Clutter      Sea clutter refers to the reflected echos from ocean waves. The clutter is displayed in the central part of the screen and increases in width as the height of waves increase. Too little sea clutter filtering allows objects to be obscured by the clutter and increases the risk of collision. Too much sea-clutter filtering can prevent contacts from displaying.

---

C.7.g. Rain Clutter      Rain clutter can display on the radar when the boat is in or near rain or snow. The Rain clutter control breaks the continuous display of rain or snow reflections into a random pattern. Rain control can also be used to reduce the target clutter in good weather in busy harbours. Too little rain-clutter filtering allows objects to be obscured by the clutter. Too much rain-clutter filtering can prevent contacts from displaying.

---

C.7.h. Sea & Rain Clutter Limitations      The height of most radar transmitters is 6 ft to 14 ft above the surface of the water. This height does not allow for true tuning of sea clutter and rain clutter. Adjusting the sea or rain clutter can have the opposite effect as intended due to the low height of radar. Adjustments should be performed in small increments and used sparingly only during heavy weather.

---



C.7.i. Noise & Interference Rejection

Radar interference can occur when the boat is near the radar of another vessel that operates on the same frequency. The interference displays on the screen as many bright dots. The dots can be random or can resemble dotted lines that run from the center of the display to the edge. The interference rejector is a filter setting internal to the radar’s software that removes radar interference from the screen. To prevent the loss of weak targets, turn off the interference rejector when there is no interference.

C.7.j. Common Radar Contacts

A list of common radar contacts and reflection quality follows:

Contact	Integrity
Reefs, shoals, and wrecks	May be detected at short to moderate ranges, if breakers are present and are high enough to return echoes. These echoes usually appear as cluttered blips.
Sandy spits, mud flats, and sandy beaches	Return the poorest and weakest echoes. The reflection, in most cases, will come from a higher point of land from the true shoreline such as bluffs or cliffs in back of the low beach. False shorelines may appear because of a pier, several boats in the area, or heavy surf over a shoal.
Isolated rocks or islands off shore	Usually return clear and sharp echoes providing excellent position information.
Large buoys	May be detected at medium range with a strong echo; small buoys sometimes give the appearance of surf echoes. Buoys equipped with radar reflectors will appear out of proportion to their actual size.
Piers, bridges, and jetties	Provide strong echoes at shorter ranges.
Rain showers, hail, and snow	Will also be detected by radar and can warn of foul weather moving into the area. Bad weather appears on the screen as random streaks known as ‘clutter’.
Vessels	Return will depend on size, construction material (wood, fibreglass, aluminium, steel), and direction of travel.



C.7.k. Echo Trails

Echo trails are images on the radar that show the previous positions of radar contacts over a present period of time. Echo trails show the movements of radar contacts and help alert to possible collisions. The disadvantage of using echo trails is that over a period of time, returns from land can paint a band across the screen that may obscure weak contacts.

Echo trails display on the radar for a specific amount of time, then the trails are erased and restarted. Echo trail time can be set from seconds to continuous. The longer the echo trail time, the longer the trail that displays on the screen.

C.7.l. Heading Mark

The straight line outstretched from the center of the screen indicates the direction the boat is pointing.

C.7.m. Fixed Range Rings

Range rings are used to estimate the distance from the boat to a contact. Range rings display as concentric solid circles emanating out from the center of the screen. The number of rings is automatically determined by the selected range scale. The distance between range rings (interval) is displayed on the screen.

Major range scales are indicated in miles and are then subdivided into range rings. Typical range scales for a boat radar are ½, 1, 2, 4, 8, and 16 NM. Typical number of range rings for a particular range scale are shown as follows:

Scale/Miles	Rings	NM Per Ring
½	1	½
1	2	½
2	4	½
4	4	1
8	4	2
16	4	4

To measure the range to a target using range rings:

Step	Procedure
1	Count the number of rings between the center of the display and the contact.
2	Multiply the number of rings by the range ring interval.
3	Estimate the distance from the contact to the nearest inner ring, and add that number to the range ring distances.



C.7.n. Variable Range Marker (VRM)

Variable Range Markers (VRM) measure the distance from the boat to a contact. The VRM displays as a ring around the boat on the radar. Data for the selected VRM is displayed on the screen. Adjusting the size of the ring until it touches the contact will give the distance to the target.

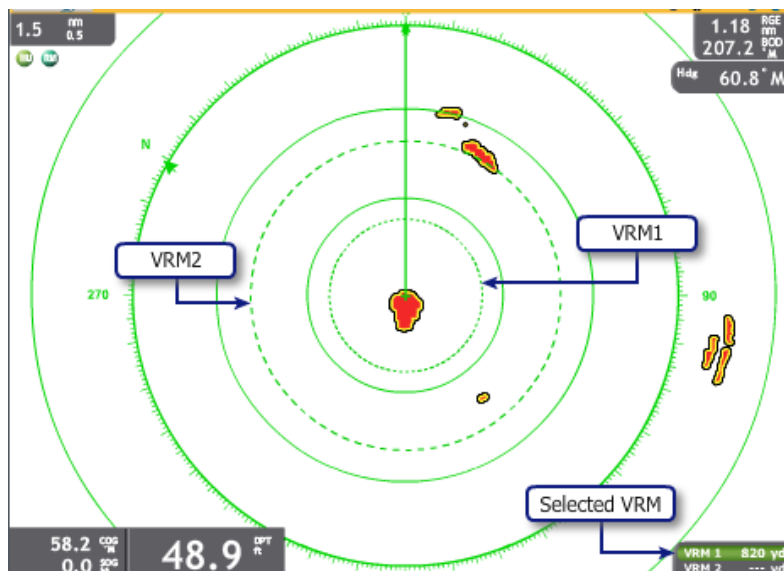

Figure 3-28  
Variable Range Marker (VRM)

C.7.o. Electronic Bearing Lines

Electronic Bearing Lines (EBL) measure the bearing from the boat to a contact. Radar bearings can be measured in true, magnetic, or relative direction. To obtain a target bearings, the EBL is adjusted until the line crosses the target.

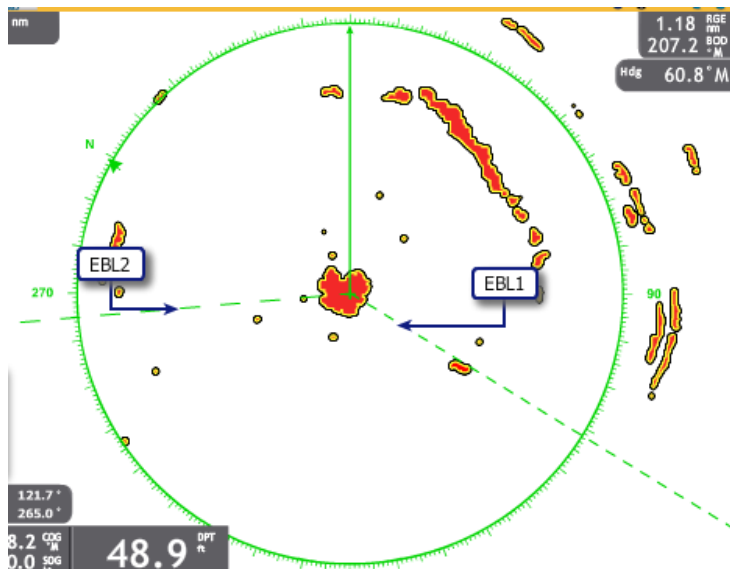

Figure 3-29  
Electronic Bearing Line



C.7.p. Automatic Radar Plotting Aid (ARPA)

The Automatic Radar Plotting Aid (ARPA) is a feature that allows you to track the movement of up to 30 radar contacts. ARPA also provides information about each tracked contact, such as Course Over Ground (COG), speed, range, bearing, and Closest Point of Approach (CPA). Targets can be acquired manually, or an ARPA acquisition area can be established so any contact that enters the area is automatically acquired and tracked.

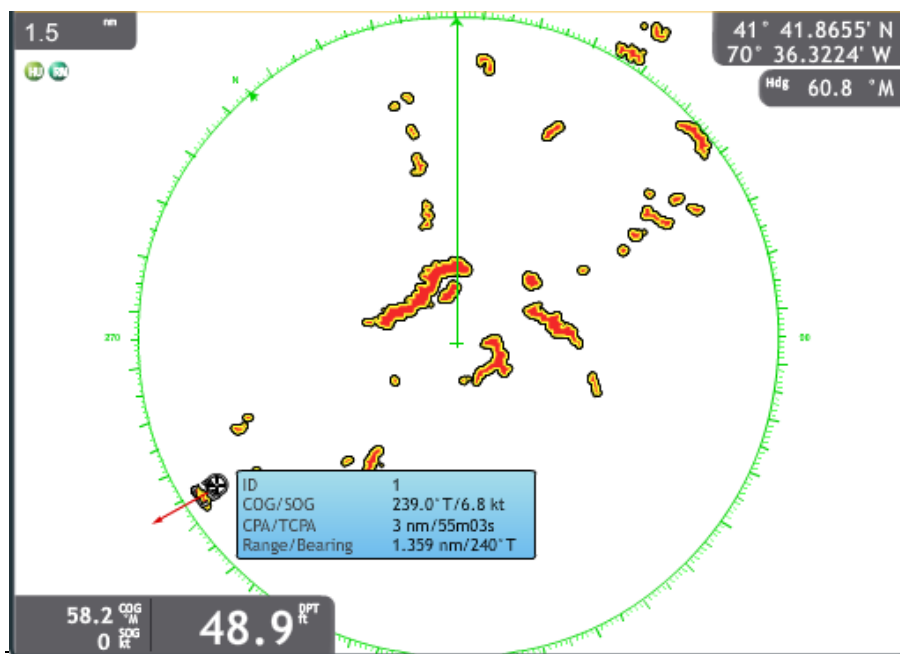

Figure 3-30  
Automatic Radar Plotting Aid (ARPA)

C.7.q. Collision Avoidance

Your own vessel is always at the center of the radar screen, unless the user inputs an offset. If you are moving toward a stationary object, such as a day beacon, the radar picture will give the impression that you are stationary and the day beacon is moving toward you. This is known as relative motion as the radar shows the day beacon is changing position relative to your own vessel rather than its fixed position on the surface of the Earth. When considered with a moving object the relative motion depends on the movement of both your vessel and the tracked object. The movement of a contact across a radar screen is seldom an accurate representation of the target's movement across the Earth.

C.7.r. Assessing Risk

Constant bearing associated with a risk of collision can be determined by using the EBL. If the contact is another vessel and appears to slide straight along the EBL the implication is that it is on a constant bearing and there is a risk of collision. Unless someone takes action to change the situation the contact will continue along the EBL until it reaches the center of the screen, the position occupied by your boat.



### C.8. Depth Sounder

There are several types of depth sounders, but they operate on the same principle. The depth sounder is the most accurate way to determine the depth of water. The depth sounder transmits a high frequency sound wave that reflects off the bottom and returns to the receiver. The “echo” is converted to an electrical impulse and can be read on a depth sounder display. It shows only the depth of water the vessel is in. Depth sounders can be set to fathoms (one fathom = 6 feet), feet, or meters. Ideally the units displayed should be the same as those of the chart being used.

#### C.8.a. Transducer

The transducer is the part of the depth sounder that transmits the sound wave. It is usually mounted permanently in the bottom or under the transom on the centreline. Transducers, if installed, are not always located at the lowest point of a boat. The distance from the transducer to the lowest point of the hull must be known. This distance must be subtracted from the depth sounding reading to determine the actual depth of water available.

Example: Depth sounder reading is 6 feet. The transducer is 1 foot above the lowest point of the hull - the boat extends 1 foot below the transducer. This 1 foot is subtracted from the reading of 6 feet, which means the boat has 5 feet of water beneath it.

#### C.8.b. Offset

Offset is a function available in most depth sounders. Its purpose is to compensate for the display of available depth from the sensor location on the hull to the actual lowest point of the vessel (**Figure 3-32**). When the offset value is reading correctly, zero ft beneath the keel means the lowest part of the vessel is touching the bottom, even though the actual transducer location may be several feet from the bottom.

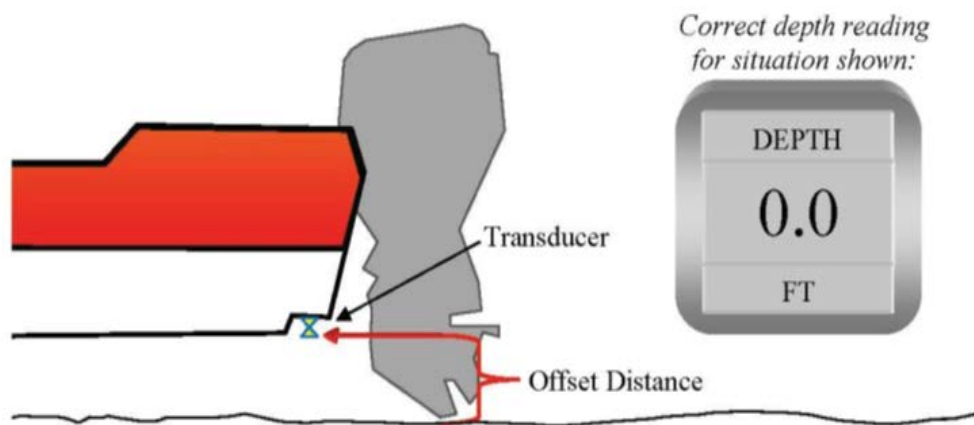

Figure 3-31  
Offset



C.8.c. Depth  
Sounder /  
Transducer in  
Aerated Waters

The accuracy of even the best transducers can be severely impacted, or rendered completely useless, in aerated water. This is likely to occur when operating in heavy seas, high speeds, during turns, backing down, or when station keeping on waterjet powered boats. In these conditions the depth sounder should not be relied upon for accurate readings.

When operating at high speeds, it is unlikely that a coxswain will be able to react to avoid grounding if relying solely on the depth sounder to determine depth of water. When in doubt slow down to improve the quality of water flow past the transducer and allow more time to react to a change in depth.

Coxswain should always take advantage of other means to verify water depth, such as charts or chart plotter.

C.8.d. Alarms

Depth sounders are equipped with audible and visual alarms triggered at a specified depth of water. How close to bottom should a vessel get before an alarm sounds? The answer is based on the amount of reaction gap needed to address and respond to the situation. Establishing a navigational draft, meaning a depth of water that serves as the threshold for operations, is a prudent step to ensure timely warning and response prior to a portion of the boat making contact with the bottom. In determining an appropriate navigational draft the following conditions should be considered:

- (01) Too small of a value results in an alarm that sounds when the vessel is already in peril, or does not allow for reaction to avoid peril.
- (02) Too large of a value results in over-alarms, becomes a nuisance, and erodes confidence in alarm value by surpassing your alarm threshold.

Ideally a specified navigational draft will be the total vessel draft (including appendages in displacement mode) plus a safety margin. Factoring negative height of tide may also be needed in some situation. **Figure 3-32** indicates the concept in greater detail.

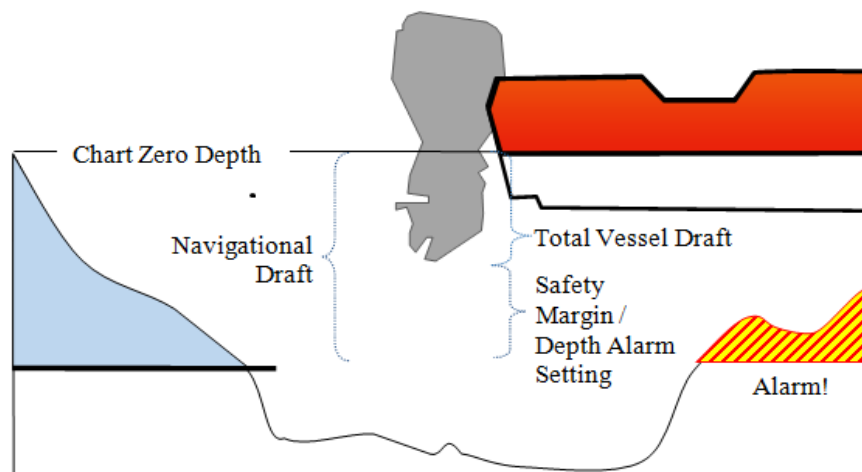

**Figure 3-32**  
Navigational Draft



### C.9. Automatic Identification System (AIS)

The Automatic Identification System (AIS) provides timely vessel identification and collision avoidance information to vessels within Very High Frequency (VHF) range. AIS transmits and receives detailed static, dynamic, voyage related, and safety information. AIS integrated into radar or an electronic chart display includes a symbol at the position of every significant ship transmitting AIS within radio range, along with an associated velocity vector indicating the boat's speed and heading and maneuvering information including closest point of approach (CPA) and time to closest point of approach (TCPA).

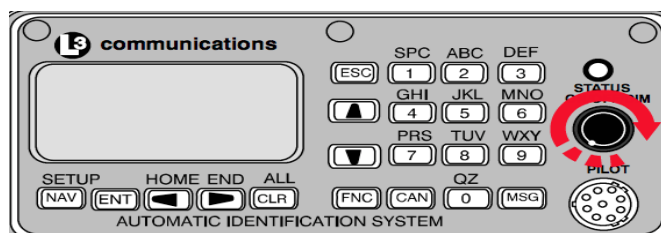

Figure 3-33  
AIS Receiver

#### C.9.a. Maritime Mobile Service Identities (MMSIs)

Maritime Mobile Service Identities (MMSIs) are nine digit numbers used by AIS and other integrated navigation and communication equipment to uniquely identify a vessel, coast radio station, or aid to navigation. MMSI greatly aids efforts to communicate with other vessels by allowing boat crews to immediately identify a vessel by name and hail them directly via VHF-FM or DSC enabled radio instead of a typical radio call out to the “ship off my starboard bow” or other broad non-specific means.

#### C.9.b. Operating Modes

CLASS-A is the standard mode, which complies with the internationally accepted mode of operation.

TX Disabled is a receiving only mode. It allows users in this mode the ability to view others but not allows other vessels to view operators using TX Disabled.

Secure TX is primary mode of operation for most government boats. It allows users to view vessels operating within Class-A mode, but does not allow those vessels to view Secure TX vessels. Vessels using this mode can view others using the same mode.





C.9.c.  
 Information  
 Broadcast

AIS broadcasts the following information every 2 to 10 seconds while underway and every 3 minutes while at anchor:

- (01) MMSI number,
- (02) Navigation status,
- (03) Speed over ground,
- (04) Position accuracy,
- (05) Longitude,
- (06) Course over ground,
- (07) True heading,
- (08) Time stamp.

In addition, AIS will broadcast the following every 6 minutes:

- (09) Radio call sign,
- (10) Name,
- (11) Type of ship/cargo,
- (12) Dimensions of ship,
- (13) Location of ship where reference point for position is located,
- (14) Type of position fixing device,
- (15) Draft of ship,
- (16) Destination.

C.9.d. Range

The range of the standard AIS is limited to the range of VHF transmissions, which is approximately thirty miles. The long range mode is intended to allow the exchange of ships position information from ship to a competent authority via a satellite interface such as Inmarsat-C which is already onboard many ships.

C.9.e.  
 Distributed  
 Track Data

Distributed track data is viewable on electronic navigation packages when integrated. Main displays of both the plotter and radar will show track data similar to an acquired target on a radar screen, but provided via AIS.

Symbol	Target type	Color
COG →	AIS target	Blue
	Dangerous AIS target	Red
	Lost AIS target	Blue

Figure 3-34  
 AIS Distributed Track Data



C.9.f. Security

Due to the unauthenticated and unencrypted nature of AIS, the system is vulnerable to different threats like spoofing, hijacking and availability disruption. Like position data, all information obtained using AIS should be verified using available means.

**C.10. Autopilot**

Autopilot is a tool that automates the steering of your vessel by steering a designated heading, either by direct input or through external input such as the GPS or chart plotter. The autopilot is able to steer the boat through the integration of a heading sensor, rudder control and its own internal processor. There are several types of autopilots on the market but general advantages to the boat crew are:

- (01) More accurate than traditional helmsman,
- (02) Assists with long transit courses steered(reduced burden of steering),
- (03) Reduce steering system wear and tear,
- (04) Integrated with navigation system to follow active waypoints,
- (05) Able to check other systems/input more easily (traffic, depth, chart plotter, etc).

Types of steering modes or inputs vary by manufacturer and you should check with the operator's manual for your particular brand of autopilot but similar features of most autopilots are:

- (06) Standby/Manual steering mode,
- (07) Automatic mode,
- (08) Navigation mode.

Standby/manual steering mode allows for the autopilot to be on but requires manual steering by a helmsman. Whenever transiting in or out of harbor or in close maneuvering situations, the autopilot should not be used.

Automatic mode allows for a quick course input for steering. When used, automatic mode should only be used over short courses as it may not account for set or drift and can lay your boat into danger.

Navigation mode takes current active waypoint information and derives an appropriate course to steer. Navigation mode will account for set and drift to ensure a proper course and can automatically shift to another waypoint once current waypoint has been reached.

One disadvantage of an autopilot is it may have a tendency to over steer when acquiring a course. If for example, a course of 300 degrees is ordered but current heading is 200 degrees, some autopilots have a tendency to go slightly to the right past 300 degrees and then when correcting it may overcorrect slightly to the left until it steadies on 300 degrees. An autopilot may do this briefly until the heading sensor information and timing of the rudder inputs align.



---

## Section D. Direction

---

### Introduction

Navigation deals with varied types of direction. To distinguish between them each has a unique name and an associated specific meaning.

Heading is the direction in which the vessel is pointing at any given moment. Very rarely is it the same as course.

Course is the direction the vessel is intended to be steered.

Course Over Ground is the direction the vessel is moving over the surface of the Earth. The effects of wind and tide cause it to differ from heading. Terms such as Track Angle, Ground Track, and Course Made Good can also be used.

Bearing is the direction to an object from another object.

---

### In this Section

This section contains the following information:

Title	See Page
<a href="#">Direction</a>	3-52
<a href="#">Compass</a>	3-54
<a href="#">Adjustments</a>	3-68
<a href="#">Course and Bearings</a>	3-69



## Direction

### D.1. Cardinal Directions

The four **cardinal directions** or **cardinal points** are the directions of north, east, south, and west, commonly denoted by their initials: N, E, S, W. East and west are at right angles to north and south, with east being in the clockwise direction of rotation from north and west being directly opposite east. Intermediate points between the four cardinal directions form the points of the compass. The **intermediate directions** are northeast (NE), southeast (SE), southwest (SW), and northwest (NW). Intermediate directions can be further divided into secondary-intercardinal directions ( i.e. NNE, ENE, ESE, etc), resulting in a total of 32 named points evenly spaced around the compass.

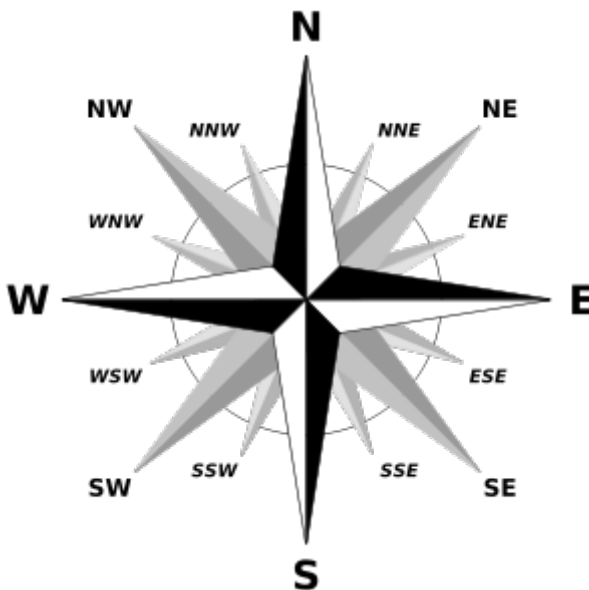

Figure 3-35  
Cardinal Directions

The directional names are also associated with the degrees of circle's rotation, a necessary step for navigational calculations and for use with Global Positioning Satellite (GPS) receivers. The four cardinal directions correspond to the following degrees of a compass:

- (01) North (N):  $0^{\circ} = 360^{\circ}$ ,
- (02) East (E):  $90^{\circ}$ ,
- (03) South (S):  $180^{\circ}$ ,
- (04) West (W):  $270^{\circ}$ .



**D.2. Reference Point/Reference Direction**

The usual reference point is 000°. The relationships between the reference points and reference directions are listed below:

<b>Reference Direction</b>	<b>Reference Point</b>
True (T)	Geographical North Pole
Magnetic (M)	Magnetic North Pole
Compass (C) *	Compass North
Relative (R) *	Boat's Bow

\* Not to be plotted on a chart.

**D.3. Three Figure Notation**

Cardinal points are used for approximate directions, but for navigational purposes have been replaced by the three figure notation. This system refers to direction as angles measured in degrees that are counted clockwise from north at 000° to 359°. When speaking of degrees in giving course or heading, three digits should always be used, such as 270° or 057°. The heading of 360° is always referred to or spoken as 000°.



#### D.4. Heading Sensor

Heading is the direction in which the vessel is pointing at any given moment. Electronic heading sensors have largely replaced the magnetic compass as the primary means of determining a vessel's heading, with the magnetic compass normally serving only as an emergency backup. An electronic heading sensor is installed on most modern boats and is normally mounted low on the centerline. The sensor detects terrestrial magnetism and produces heading data, which is utilized by electronic navigation system components that need accurate and stable heading input such as an electronic charting system and radar.

Heading accuracy of these sensors is typically  $\pm 1^\circ$ . Heading data is shown in three figure notation (ie. 000°) and can be adjusted to display as either True or Magnetic, depending on user preference and standard operating procedures.

Though used by larger vessels, the gyrocompass will not be discussed since it is not commonly used by boats.

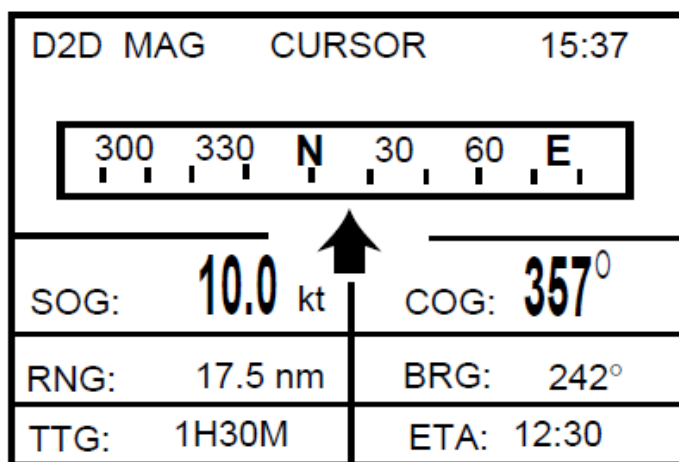

Figure 3-36  
Heading Sensor Data Shown on GPS Display

#### Compass

#### D.5. Magnetic Compass

The magnetic compass is installed on most boats and is used to determine heading. Mechanically, it is a simple piece of equipment that senses the direction of the Earth's magnetic field by employing several magnets, or a single ring shaped magnet, mounted on a circular card marked with a scale of degrees or compass points suspended in a mixture of water and alcohol. A prudent seaman will check its accuracy frequently, realizing that the magnetic compass is influenced not only by the earth's magnetic field, but also by electromagnetic fields radiating from magnetic materials aboard the boat. It is also subject to error caused by violent movement as might be encountered in heavy weather.



**D.5.a. Compass Card**

The arc of the compass card is divided into 360 degrees (°) and is numbered all the way around the card from 000° through 359° in a clockwise direction. Attached to the compass card is a magnet that aligns itself with the magnetic field around it. The zero (north) on the compass card is in line with the magnet or needle attached to the card. When the boat turns, the needle continues to align itself with the magnetic field. This means the compass card stays stationary and the boat turns around it (**Figure 3-37**).

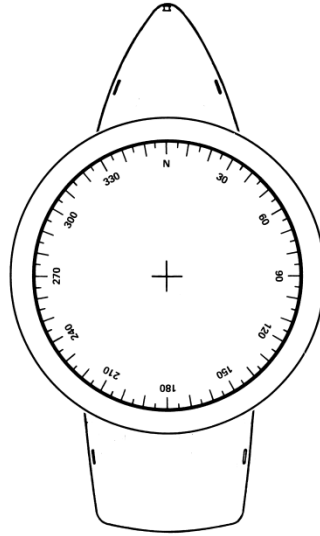

**Figure 3-37**  
**Compass Card**



D.5.b. Lubbers Line

The lubber's line is a line or mark scribed on the compass housing to indicate the direction in which the boat is heading. The compass is mounted in the boat with the lubber's line on the boat's centerline and parallel to its keel (**Figure 3-38**).

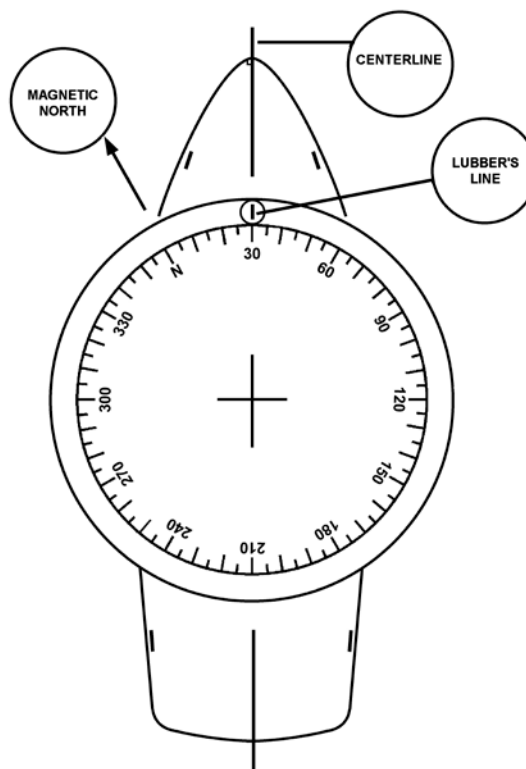

Figure 3-38  
Lubber's Line and Magnetic North

D.6. Compass Error

Compass error is the angular difference between a compass direction and its corresponding true direction. The magnetic compass reading must be corrected for variation and deviation.

Errors in variation and deviation are automatically calculated and corrected by a properly calibrated electronic heading sensor. An error in the output of a heading sensor indicates probable failures of calibration, start sequence, or positioning of metals near the sensor's location.





### D.7. Variation

Variation is the angular difference, measured in degrees, between true and magnetic north. It varies according to geographic location. The amount of variation changes from one point to the next on the earth's surface. It is written in degrees in either an easterly or a westerly direction. The variation is on the inside of the compass rose of the chart.

Increases in variation may continue for many years, sometimes reaching large values, remaining nearly the same for a few years and then reverse its trends (decrease). Predictions of the change of variation are intended for short-term use, that is a period of only a few years. The latest charts available should always be used. The compass rose will show the amount of predicted change.

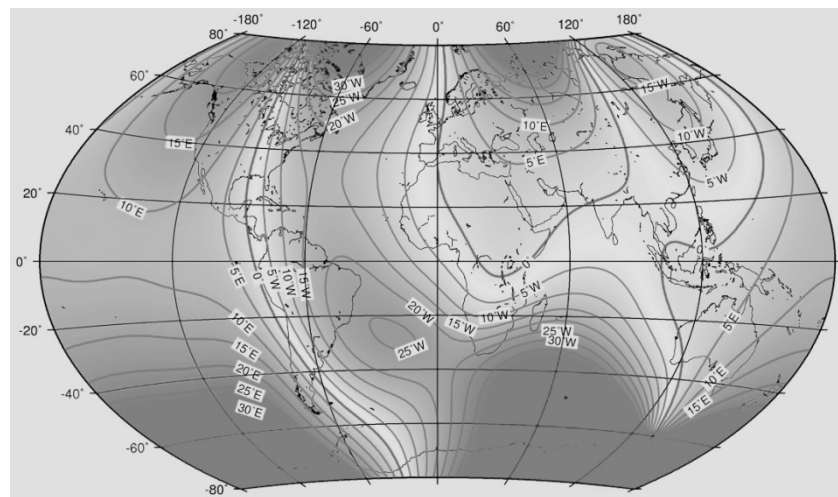

**Figure 3-39**  
**Earth's Magnetic Field and lines of Variation**



D.7.a. Obtaining Variation

Variation information for the chart in use is found in the center of the compass rose. This information is only accurate to the date printed on the chart. The amount of variation changes from one point to the next on the earth's surface. Variation can increase or decrease. Refer to the chart in use.

Variation is written in degrees in either an easterly or westerly direction. This depends on which side the variation is in relation to true north.

Variation remains relatively the same for all headings in the same geographic area. It changes due to geographic location. There are many compass roses on one chart. Variation may even differ from compass rose to compass rose on the *same* chart. Easterly or westerly direction is defined:

- (01) Variation is considered **easterly (E)** if the compass needle aligned with the magnetic meridian points eastward or to the right of true north (**Figure 3-40**).
- (02) Variation is considered **westerly (W)** if the compass needle points westward or to the left of true north (**Figure 3-41**).

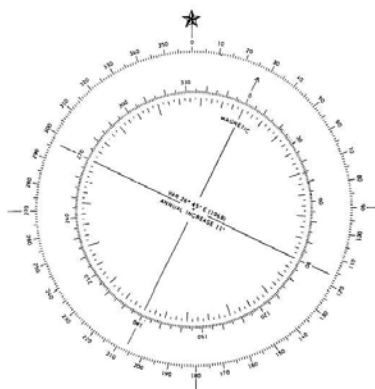

**Figure 3-40**  
**Easterly Error Variation**

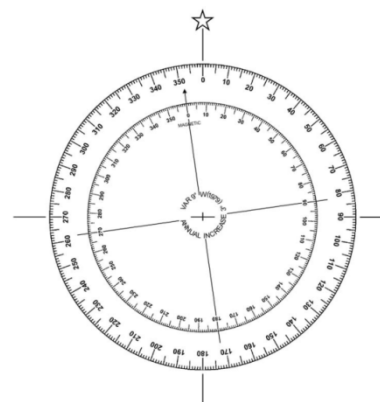

**Figure 3-41**  
**Westerly Error Variation**



D.7.b.  
Calculating  
Variation

Perform the following the procedures for determining the amount of annual increase or decrease of variation:

Step	Procedure
1	Locate the compass rose nearest to area of operation on the chart.
2	Locate the variation and annual increase/decrease from the center of the compass rose.
3	Locate the year from the center of the compass rose where variation and the year are indicated.
4	Subtract year indicated in the compass rose from the present year.
5	Multiply the number of years difference by the annual increase or decrease.
6	Add or subtract the amount from step 5 to the variation within the compass rose.

**D.8. Deviation**

Deviation is the amount of deflection influenced by a vessel and its electronics on the compass. It varies according to the heading of the vessel and can be caused by:

- (01) The materials used in the hull and superstructure of the boat or cutter.
- (02) Metal objects that are placed near the compass.
- (03) Electrical motors and electronic systems on the vessel.

When the compass bearing is less than the magnetic bearing - deviation (error) is east. When the compass bearing is greater than the magnetic bearing - deviation (error) is west.

Deviation creates an error in the compass course that a boat attempts to steer. For navigational accuracy and the safety of the boat and crew, the boat's compass heading must be corrected for deviation so that the actual magnetic course can be accurately steered.

Deviation changes with the boat's heading; it is *not* affected by the geographic location of the boat.

**NOTE**

Magnetic compasses and electronic heading sensors that rely on the Earth's magnetic fields for direction are both subject to interference from objects around them including metal objects, cell phones, energized equipment, and portable radios.



### D.9. Magnetic Compass Deviation Check

Compass errors must accurately be known, recorded and posted. This is accomplished for a magnetic compass by conducting a deviation check or “swinging the compass” to determine deviation (**Figure 3-42**). The results of this check are recorded on a deviation table (**Table 3-2**) posted in the boat near the compass. This table should be updated annually and after any addition or deletion of equipment or structural alterations that would affect the magnetic characteristics of the boat.

Due to limited landmarks, operating depth’s and availability of aids to navigation which exist in some operating areas, different methods for determining magnetic compass deviation may be used. Determine which method works best for your operating area. Available methods include:

- (01) Running a range.
- (02) Multiple observations from one position.
- (03) Multiple ranges.

Prior to start ensure that there are no local magnetic anomalies, (such as wrecks, pipe lines, bridges or steel piers), near the boat in the selected area that could affect the local variation indicated on the chart. Choose an alternate location if any magnetic interference is found in the selected area.

**NOTE**

No deviation table is required for an electronic heading sensor.

**NOTE**

A navigational aid range is a line down the center of a channel or harbor entrance connecting two charted beacons. A terrestrial range is two natural or manmade charted objects that are observed to be in line with each other, such as a church steeple and a water tower.

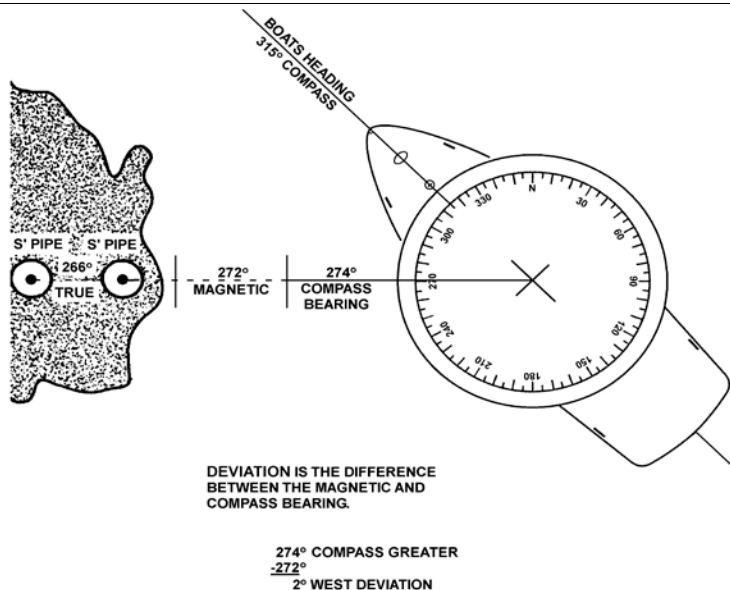

**Figure 3-42**  
Deviation Check Using Ranges



D.9.a. Running a Range

STEP	PROCEDURE
1	Find the magnetic bearing of the selected range on the nautical chart using parallel ruler.
2	Enter the boats compass heading for every 15° in column (1) of the deviation work table ( <b>Table 3-2</b> ).
3	Enter the range’s magnetic bearing as measured on the chart in column (3) of the deviation work table ( <b>Table 3-2</b> ); this will be the same value for all entries.
4	Get the boat underway at slow speed in calm water.
5	Steer the boat’s first compass heading, 000°, listed in column (1) of the deviation work table ( <b>Table 3-2</b> ).
6	Cross the range while steering a steady heading and Observe the compass bearing of the range at the instant the range is crossed.
7	Alter course, changing by 15° increments, until the range is crossed and the compass bearing of the range for each compass heading is recorded in column (2) of the deviation work table ( <b>Table 3-2</b> ).
<b>NOTE</b>	 <div style="border: 1px solid black; padding: 2px;">                     When the compass bearing is less than the magnetic bearing, deviation (error) is east. When the compass bearing is greater than the magnetic bearing, deviation (error) is west.                 </div>
8	Determine deviation for each heading by taking the difference between the magnetic bearing and the compass bearing.
9	Record deviation for each heading in column (5) of the deviation work table ( <b>Table 3-2</b> ).
10	Post the deviation table adjacent to the boat compass for use while underway.



(1) Boats Compass Heading	(2) Compass Bearing of Range	(3) Magnetic Bearing of Range	(4) Deviation	(5) Magnetic Course
000°				
015°				
030°				
045°				
060°				
075°				
090°				
105°				
120°				
135°				
150°				
165°				
180°				
195°				
210°				
225°				
240°				
255°				
270°				
285°				
300°				
315°				
330°				
345°				

\* When the compass bearing is less than the magnetic bearing – deviation (error) is east.  
 \* When the compass bearing is greater than the magnetic bearing – deviation (error) is west.  
 \* Compass least, error east; Compass best, error west.  
 \* Subtract easterly errors; add westerly errors.

Table 3-2  
Deviation Work Table

D.9.b. Multiple  
Observations  
from One  
Position

STEP	PROCEDURE
1	Locate an accurately charted object.
<b>NOTE</b> ☞	To use this method, an accurately charted object such as a solitary piling, with maneuvering room and depth around it must be available. In addition, there must be charted and visible objects, suitable for steering on with accuracy, at a distance of greater than ½ mile.
<b>NOTE</b> ☞	Use the largest scale chart available covering the local area.
2	Determine and record the magnetic bearing/reciprocal bearing from the chart (from piling to object) of various selected objects.
3	Record objects/bearings from above step in columns (1) and (2) of observation table ( <a href="#">Table 3-3</a> ).



<b>4</b>	Tie off to the piling or object identified in Step 1.
<b>5</b>	With the piling or object amidships, pivot around it and steer on the objects identified in the observation table.
<b>6</b>	Record each reading in column (3) of the observation table ( <b>Table 3-3</b> ).
<b>7</b>	Compare columns (2) and (3) of the observation table to obtain the deviation for that heading, Record deviation in column (4) of the observation table ( <b>Table 3-3</b> ).
<b>8</b>	Draw the deviation curve.
<b>NOTE</b>	The deviation graph in <b>Figure 3-42</b> has a horizontal axis that is divided into 15° increments of plotted magnetic heading. The vertical axis, which indicates compass deviation, has its origin in the middle of the graph; downward from the origin represents easterly deviation and upward represents westerly deviation. The increments of the vertical axis should be chosen dependent upon the amount of deviation measured in the procedure.
<b>NOTE</b>	Measured deviation, before adjustment, may be greater than the 5° depicted on the deviation curve in <b>Figure 3-43</b> . The range of the deviation curve may be extended if deviation exceeds 5°.
<b>9</b>	Plot the deviations from column (4) and magnetic heading from column (2) of the observation table ( <b>Table 3-3</b> ) on to the deviation curve as show in the sample deviation curve (Fig 14-41).
<b>10</b>	Draw a deviation curve by connecting the plotted deviations as shown in the sample deviation curve ( <b>Figure 3-44</b> ).
<b>11</b>	Observe deviation curve established on the deviation graph, to be used to extrapolate the deviation for any measured compass heading.
<b>12</b>	Record deviation for all measured findings on the draft deviation table ( <b>Table 3-4</b> ).
<b>13</b>	Post the deviation table adjacent to the boat compass for use while underway.



Observation Table			
(1) Object (On Chart)	(2) Magnetic Heading (Plotted)	(3) Compass Heading (Measured)	(4) Deviation (Calculated)
* When the compass bearing is less than the magnetic bearing – deviation (error) is east. * When the compass bearing is greater than the magnetic bearing – deviation (error) is west. * Compass least, error east; Compass best, error west. * Subtract easterly errors; add westerly errors.			
Example Observation Table			
(1) Object (On Chart)	(2) Magnetic Heading (Plotted)	(3) Compass Heading (Measured)	(4) Deviation (Calculated)
Steeple	013°	014.0°	1.0° W
Stack	040°	041.5°	1.5° W
R. Tower	060°	062.0°	2.0° W
Lt #5	112°	115.0°	3.0° W
Left Tangent Pier	160°	163.0°	3.0° W
Water Tower	200°	201.0°	1.0° W
Right Jetty	235°	235.0°	0.0° W
Light House	272°	271.0°	1.0° E
Flag Pole	310°	309.0°	1.0° E
Lookout Tower	345°	344.5°	0.5° E

Table 3-3  
Observation Table



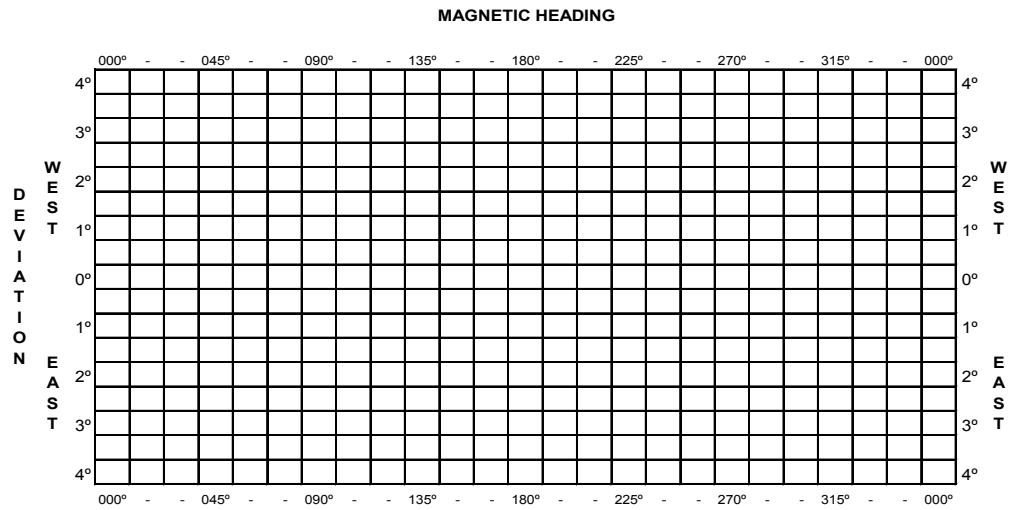

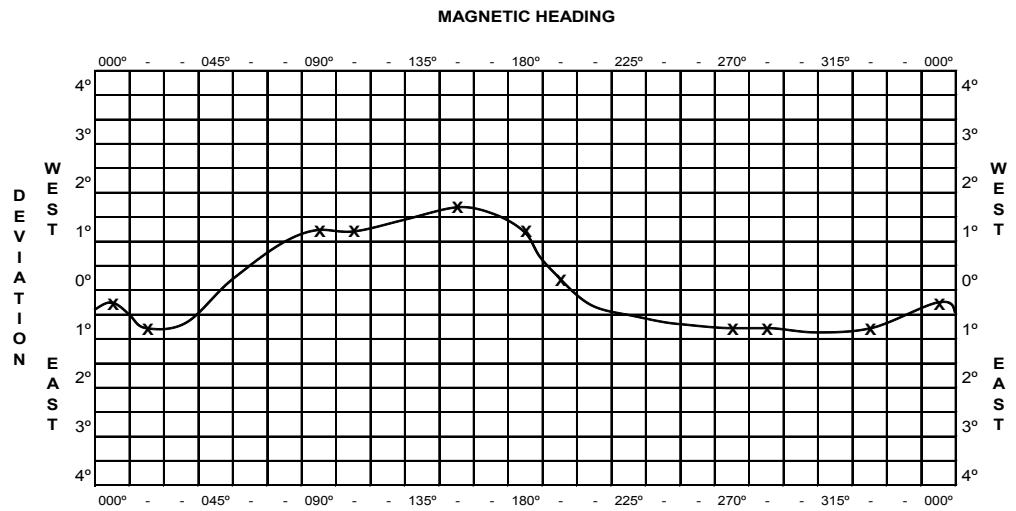

**Figure 3-43**  
**Deviation Curve**





**Figure 3-44**  
**Example Deviation Curve**



D.9.c. Multiple  
Visual Ranges

STEP	PROCEDURE
1	Identify as many terrestrial ranges as possible that will be visible when underway and which also provide lines of position across expanses of water with adequate maneuvering room and depth.
<b>NOTE</b> 	Chosen ranges must be suitable for steering on with accuracy at a distance greater than ½ mile.
<b>NOTE</b> 	A minimum of four ranges (with reciprocal courses) are needed to yield deviation values for the cardinal points (N, S, E, W) and inter-cardinal points (NE, NW, SE, SW).
<b>NOTE</b> 	The ranges should ideally be in the same operating area so that variation remains constant.
2	Ensure bearings for each range across expanses of water provide adequate maneuvering room and depth.
3	Record identified ranges in column (1) of observation table as shown in column (1) of sample observation table ( <b>Table 3-3</b> ).
4	Determine the plotted magnetic bearing and reciprocal of each range. Plot each range magnetic bearing and reciprocal using local AOR nautical chart and parallel ruler.
5	Record the ranges plotted; magnetic and reciprocal bearing respectively in column (2) of observation table as shown in the sample observation table ( <b>Table 3-3</b> ).
6	Get the boat underway at slow speed in calm water.
7	Run the identified ranges on the observation table with the compass.
8	Record the observed compass headings and reciprocal bearing respectively for each range in column (3) of observation table as shown in the sample observation table ( <b>Table 3-3</b> ).
9	Compare the plotted magnetic bearings in column (2) with the observed compass headings in column (3) of the observation table ( <b>Table 3-3</b> ).
10	Calculate the difference between the plotted and measured bearings to obtain the deviation for each heading. Record the calculated deviations in column (4) of observation table as shown in the sample observation table ( <b>Table 3-3</b> ).
11	Draw the deviation curve.



<p><b>NOTE</b> </p>	<p>The deviation graph on <b>Figure 3-42</b> has a horizontal axis that is divided into 15° increments of plotted magnetic heading. The vertical axis, which indicates compass deviation, has its origin in the middle of the graph; downward from the origin represents easterly deviation and upward represents westerly deviation. The increments of the vertical axis should be chosen dependent upon the amount of deviation measured in the procedure</p>
<p><b>NOTE</b> </p>	<p>Measured deviation, before adjustment, may be greater than the 5° depicted on the deviation curve graph in <b>Figure 3-43</b>. The range of the deviation graph may be extended.</p>
<p>12</p>	<p>Plot the deviations from column (4) and magnetic heading from column (2) of the observation table on to the deviation curve as show in the sample deviation curve (<b>Figure 3-44</b>).</p>
<p>13</p>	<p>Draw a deviation curve by connecting the plotted deviations as shown in the sample deviation curve (<b>Figure 3-44</b>).</p>
<p>14</p>	<p>Observe deviation curve established on the deviation graph, to be used to extrapolate the deviation for any measured compass heading.</p>
<p>15</p>	<p>Prepare draft deviation table (<b>Table 3-4</b>). Record plotted magnetic heading data results on the draft deviation table by entering the deviation for every 15° of plotted heading as extrapolated on the deviation curve (<b>Figure 3-43</b>).</p>
<p>16</p>	<p>Post the deviation table adjacent to the boat compass for use while underway.</p>



Compass Course	Deviation	Magnetic Course
000		
015		
030		
045		
060		
075		
090		
105		
120		
135		
150		
165		
180		
195		
210		
225		
240		
255		
270		
285		
300		
315		
330		
345		

\* When the compass bearing is less than the magnetic bearing – deviation (error) is east.  
\* When the compass bearing is greater than the magnetic bearing – deviation (error) is west.  
\* Compass least, error east; Compass best, error west.  
\* Subtract easterly errors; add westerly errors.

Table 3-4  
Deviation Table

## Adjustments

### D.10. Heading Sensor Adjustment

The magnetic field around an electronic heading sensor or fluxgate is subject to change with the boat structure, engines, electronic equipment, or any ferrous materials in the vicinity. Most systems contain an automatic field distortion correction facility. To ensure correct procedures are performed always consult the sensor manufacturer’s guidelines or maintenance procedure card prior to calibration or heading alignment.

### D.11. Magnetic Compass Adjustment

If compass deviation for any heading on the deviation work table exceeds 5° have the magnetic compass calibrated by a professional compass adjuster and complete a deviation table using the professional adjuster’s observations



## Course and Bearings

**D.12. Course**      A course is the horizontal direction in which a vessel is steered or intended to be steered, expressed as the angular distance from north, usually from 000 (north), clockwise through 360. Courses steered on an electronic heading sensor can be displayed in True or Magnetic degrees. Courses steered on a magnetic compass are magnetic.

---



D.12.a. Obtaining  
True Course  
“Correcting”

“Correcting” is going from magnetic direction (M) to true (T), or going from the compass direction (C) to magnetic (M). To apply compass error:

- (01) Take the compass course.
- (02) Apply deviation to obtain the magnetic course.
- (03) Apply variation to obtain true course.

The sequence of the procedure is outlined below (see [Figure 3-45](#)):

- (01) Compass (C).
- (02) Deviation (D).
- (03) Magnetic (M).
- (04) Variation (V).
- (05) True (T).

**MEMORY  
AID**



Applying compass error:

Can Dead Men Vote Twice At Election

(Compass) (Deviation) (Magnetic) (Variation) (True) (Add) (Easterly error)

Add easterly errors - subtract westerly errors.



D.12.a.1.  
 Obtaining True  
 Course Example

For **Figure 3-45**, the compass course is  $127^\circ$ , variation from the compass rose is  $4^\circ$  W, and the deviation from the boat's deviation table is  $5^\circ$  E. Then, the true course (T) is obtained as follows:

Step	Procedure
1	Write down the correction formula: $C = 127^\circ$ $D = 5^\circ$ E $M = 132^\circ$ $V = 4^\circ$ W $T = 128^\circ$
2	Compute the information opposite the appropriate letter in the previous step.
3	Add the easterly error of $5^\circ$ E deviation to the compass course ( $127^\circ$ ) and obtain the magnetic course of $132^\circ$ .
4	Subtract the westerly error of $4^\circ$ W variation from the magnetic course ( $132^\circ$ ).
5	The true course is $128^\circ$ .

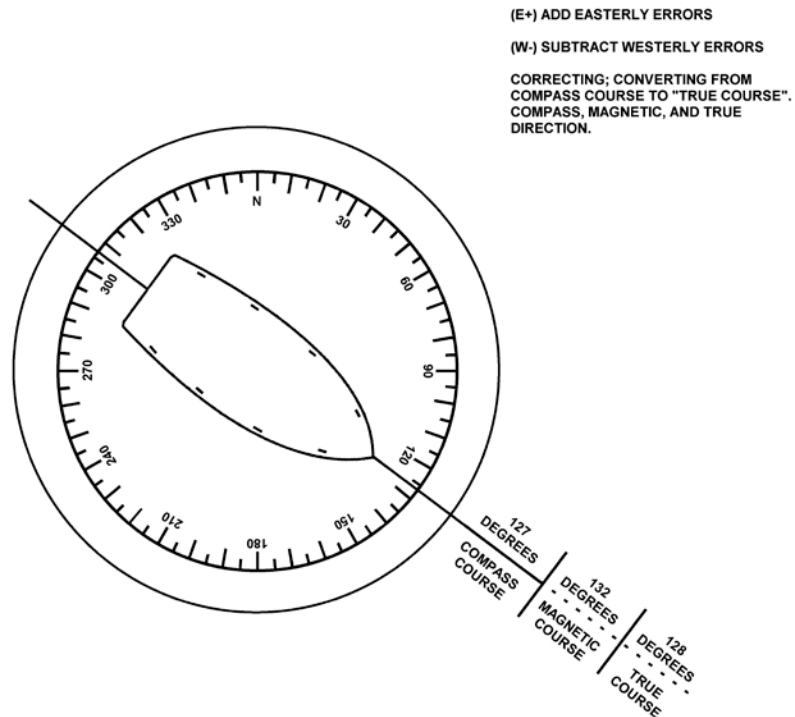

**Figure 3-45**  
 Applying Compass Error, Correcting



D.12.b. Obtaining  
Compass Course -  
“Uncorrecting”

Converting from true (T) direction to magnetic (M), or going from magnetic (M) to compass (C) is “uncorrecting.” For converting from true course to compass course:

- (01) Obtain the true course.
- (02) Apply variation to obtain the magnetic course.
- (03) Apply deviation to obtain the compass course (procedure sequence outlined in subparagraph [D.12.b.1.](#)).
- (04) True (T).
- (05) Variation (V).
- (06) Magnetic (M).
- (07) Deviation (D).
- (08) Compass (C).

**MEMORY  
AID**



Converting true course to compass course:  
Television Makes Dull Children All Weekend.  
(True) (Variation) (Magnetic) (Deviation) (Compass) (Add) (Westerly error).  
Subtract easterly errors - add westerly errors.





D.12.b.1. Obtain  
Compass Course  
Example

For **Figure 3-46**, by using parallel rulers, the true course between two points on a chart is measured as  $221^\circ$  T, variation is  $9^\circ$  E and deviation is  $2^\circ$  W. Then, obtain the compass course (C) is obtained as follows:

Step	Procedure
1	Write down the conversion formula: $T = 221^\circ$ $V = 9^\circ$ E $M = 212^\circ$ $D = 2^\circ$ W $C = 214^\circ$
2	Compute the information opposite the appropriate letter in the previous step.
3	Subtract the easterly error of $9^\circ$ E variation from true course of $221^\circ$ and obtain the magnetic course of $212^\circ$ .
4	Add the westerly error of $2^\circ$ W deviation to the magnetic course ( $212^\circ$ ).
5	The compass course (C) is $214^\circ$ .

**Figure 3-46**  
**Applying Compass Error, Uncorrecting**



### **D.13. Bearings**

Bearings are a direction, expressed in degrees from a reference point. A bearing or series of bearings can be observed as compass (C), magnetic (M), true (T), or as a relative (visual or radar). Bearings are obtained by visual sightings across a compass, hand-held bearing compass, relative bearings or by radar and measured from 000° at the reference direction clockwise through 360°. In boat navigation, magnetic courses and bearings will usually be used, since true bearings are obtained from gyrocompasses, which are not normally found on boats.

The compass bearing reading usually needs to be converted for plotting and then drawn on the chart as a line of position (LOP).

---



D.13.a.  
 Obtaining  
 Compass  
 Bearing Example  
 #1

The vessel is on a heading of  $263^\circ$  M. The compass bearing to Kays Pt. Light is  $060^\circ$ . Deviation from the deviation table on the boat's heading of  $263^\circ$  M is  $7^\circ$  W. To obtain magnetic bearing of Kays Pt. Light, perform the following procedures (see **Figure 2-1**):

Step	Procedure
1	Correct the compass bearing of $60^\circ$ magnetic. Write down the correction formula in a vertical line. (01) $C = 060^\circ$ compass bearing of light. (02) $D = 7^\circ$ W (+E, -W) from deviation table for boat's heading (03) $M =$ What is the magnetic bearing of the light?
2	Compute information opposite appropriate letter in step 1.
3	Subtract $7^\circ$ W deviation, the westerly error, from the compass bearing ( $060^\circ$ ) to obtain magnetic bearing ( $053^\circ$ ). $M = 053^\circ$

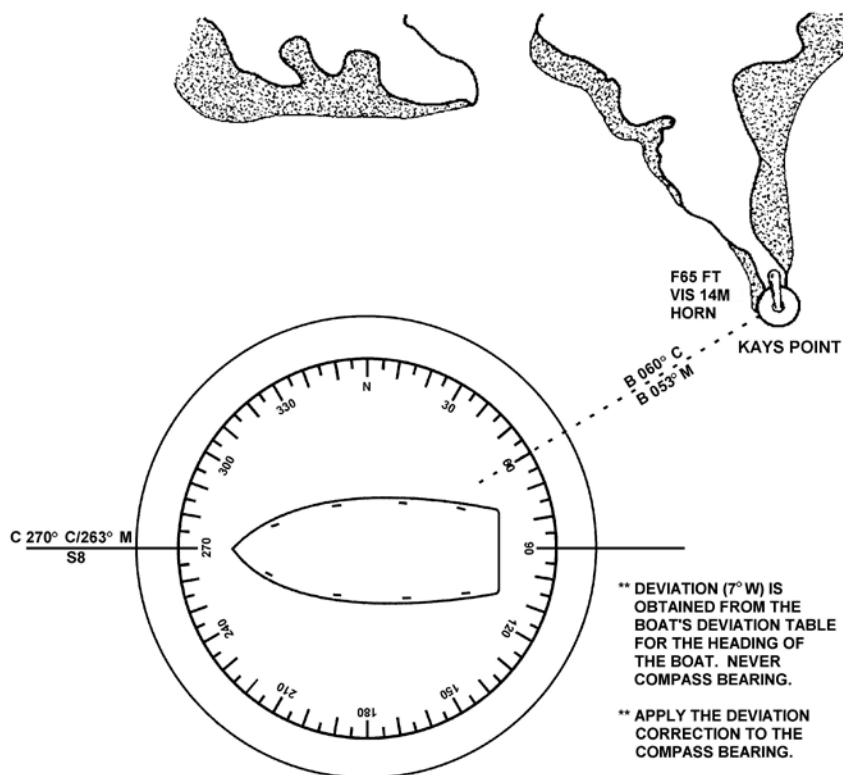

**Figure 3-47**  
 Converting Compass Bearing to Magnetic



**D.13.b**  
**Obtaining**  
**Compass**  
**Bearing**  
**Example #2**

The boat is on a heading of 285°. The relative bearing to Williams Island Rock Light is 270° relative. The relative bearing to another light is 030° relative. Deviation (from the boats deviation table) on the boat’s heading is 5° W. Obtain magnetic bearing of both lights (see **Figure 3-48**).

Step	Procedure
1	Correct your heading of 285 to the magnetic heading. Write down the correction formula in a vertical line.  (01) $C = 285^\circ$ (02) $D = 5^\circ \text{ W (+E, -W)}$ (03) $M = 280^\circ$ (04) $V = \text{not applicable to this problem}$ (05) $T = \text{not applicable to this problem}$
2	Compute information opposite appropriate letter in step 1. Subtract the westerly error, 5° W deviation from the compass heading (285°) to obtain magnetic heading (280°).
3	Add each of the observed relative bearings (270° relative and 030° relative) to the magnetic heading (280°) to obtain the magnetic bearings.  WILLIAMS IS ROCK 280° M + <u>270°</u> relative bearing 550° (greater than 360°) - <u>360</u> 190° magnetic bearing  OTHER LIGHT 280° M + <u>030°</u> relative bearing 310° magnetic bearing

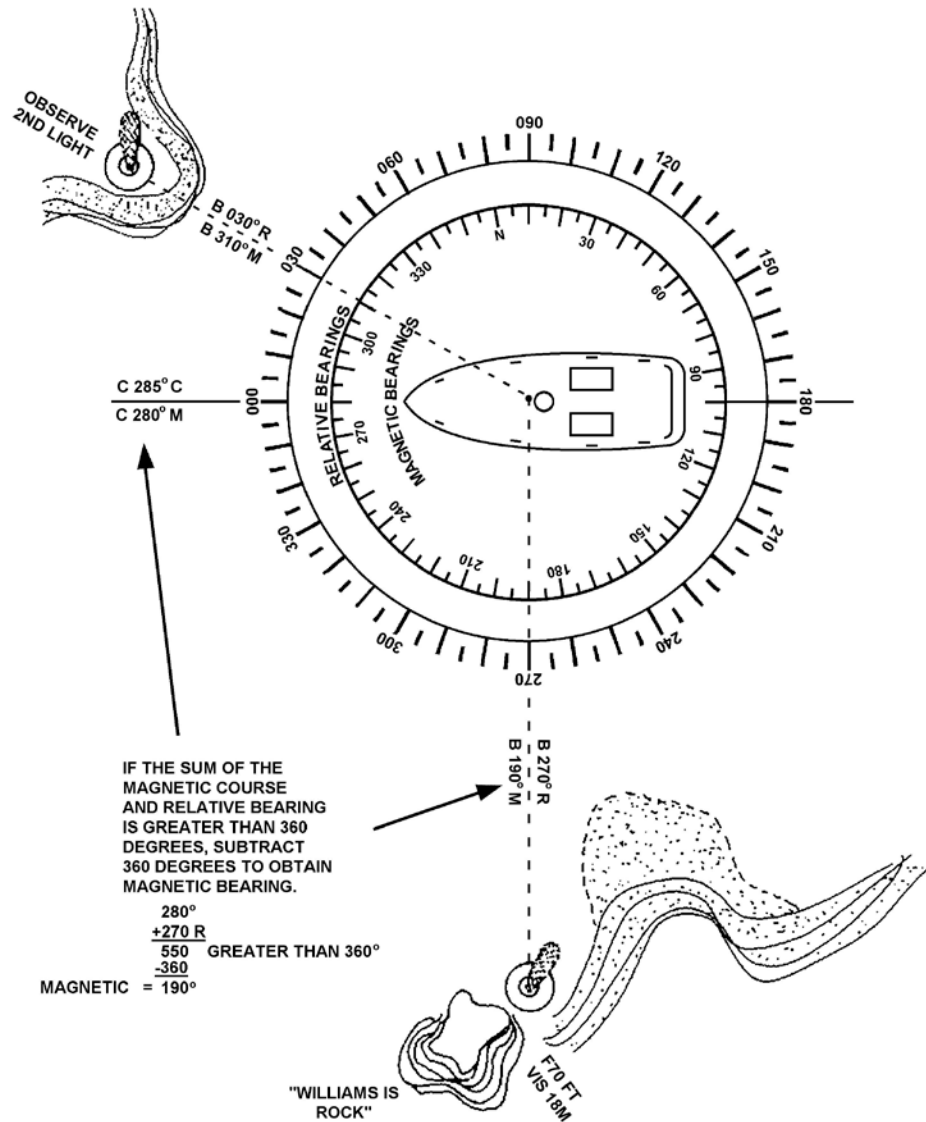

Figure 3-48  
 Converting Relative Bearings to Magnetic; Sums Greater than 360°



---

## Section E. Position

---

**Introduction** Understanding your location is a fundamental aspect of navigation. Boat crews need to know where their vessel is, where they are headed, and the location of hazards they must avoid. Knowledge of a position doesn't have to be precise in all instances and doesn't always need to be expressed in Latitude and Longitude. However it is very useful to have a method of specifying position anywhere on Earth that is precise and universally understood. Latitude and longitude provide crews this capability.

---

**In this Section** This section contains the following information:

<a href="#">Fixing and Plotting</a>	<a href="#">3-78</a>
<a href="#">Tools</a>	<a href="#">3-82</a>
<a href="#">Minutes and Conversion</a>	<a href="#">3-87</a>
<a href="#">Distance and Bearings</a>	<a href="#">3-88</a>
<a href="#">Fixes</a>	<a href="#">3-96</a>

---

### Fixing and Plotting

**E.1. Fixing Position** Knowledge of the boat's position is obtained by fixing its position. Fixing position refers to a representation of the boat's position on a paper or electronic chart that is then verified and evaluated for accuracy.

---

E.1.a. Electronic Fix The use of installed electronic equipment to develop a position fix includes:

- (01) Latitude and longitude provided by installed equipment displayed on an electronic chart or plotted on a paper chart.
- (02) The common intersection of three or more radar ranges obtained from simultaneous observations.
- (03) The use of radar/chart matching. Radar/chart matching involves fixing the vessel's position with the vessel's electronic chart using the radar to match features that appear on both (e.g., Radar overlay feature on eNav System or Fisher Plotting).
- (04) The use of a combination of visual LOPs and radar ranges is an electronic fix.

---

E.1.b. Visual Fix The common intersection of three or more LOPs (including LOPs from celestial bodies) obtained from simultaneous observations.

---



---

E.1.c. Verifying Position To avoid over-reliance on a single source of information, verify vessel position at each fix using all means available.

Vessels must use all available means to verify their position and ensure safe navigation. Techniques include secondary positioning source fix, soundings, visual observations, danger ranges/bearings, set and drift, and positive identification and relative position of aids to navigation.

Do not erase or delete fixes because they appear in error.

If position ambiguity exists, all appropriate team members (e.g., coxswain/operator, boat crewmember, or engineer) must be verbally informed and another fix taken immediately to ascertain the vessel's position.

---

E.1.d. Evaluating Fixes Current eNav systems provide reliable, robust navigation capabilities including the ability to fix, record, and display the vessel's position. A critical element to safe navigation is the ability of the person(s) responsible for navigating the vessel to accurately evaluate the vessel's position. At a prescribed fix interval, crews must ensure evaluation of the vessel's position with due regard to, at a minimum, the proximity of shoal water, environmental conditions, and mission parameters.

---

E.1.e. No Fix If at any time fix quality comes into question, particularly while operating in high risk areas (e.g., near shoal water or obstructions), crews must initiate appropriate actions to minimize risk to the vessel and crew in accordance with the Command Navigation Standards. Some actions may include:

- (01) Reducing speed,
- (02) Taking all way off,
- (03) Increasing fix frequency,
- (04) Turning away from the danger.



E.1.f. Frequency

Fixes are best taken at specific time intervals. The frequency of fixing on paper charts should, in principle, depend on the availability of position data (i.e. GPS, radar), the distance from navigational hazards, and the time the boat would take to run into danger before the next fix; it is thus at least partly speed- dependent.

Useful ‘Rules of Thumb’ for fixing on paper charts are:

- (01) 3 and 6 minute intervals between fixes are convenient for converting distance to speed, as 6 minutes is one-tenth of an hour (ie 1.35 miles in 6 minutes equals 13.5 knots). See **Rules**.
  - (02) Time fixes to coincide with the DR / EP time, in order to check for unexpected position differences.
-





## E.2. Plotting Symbols on a Paper Chart

The plotter should clearly mark an electronic fix with a triangle or a visual fix with a circle. The time of each fix should be clearly labelled. A visual running fix should be circled, marked “R Fix” and labelled with the time of the second LOP. Maintain the chart neat and uncluttered when labelling fixes.

See [Figure 3-49](#) for examples of the plotting symbols on a paper chart.

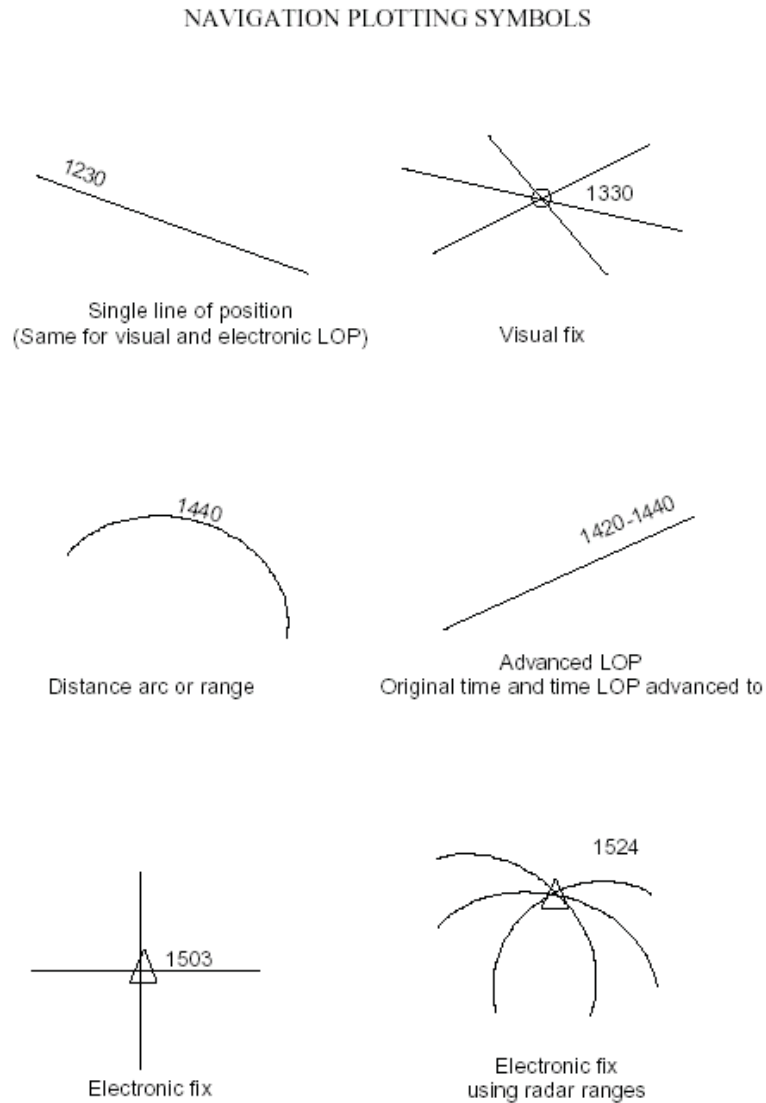

**Figure 3-49**  
**Plotting Symbols**



## Tools

---

**E.3. Paper Chart Plotting Tools** In order for a crew to make good use of a paper chart, tools such as compasses, dividers, parallel rulers, and papers must be available.

---

E.3.a. Pencils It is important to use a correct type of pencil for plotting. A medium or mechanical pencil (No. 2) is best. Pencils should be kept sharp; a dull pencil can cause considerable error in plotting a course due to the width of the lead.



E.3.b. Dividers Dividers are instruments with two pointed legs, hinged where the upper ends join. Dividers are used to measure distance on a scale and transfer them to a chart.



E.3.c. Drafting Compass The drafting compass is an instrument similar to the dividers. One leg has a pencil attached. This tool is used for swinging arcs and circles.





E.3.d. Parallel Rulers

Parallel rulers are two rulers connected by arms that allow the rulers to separate while remaining parallel. They are used in chart work to transfer directions from a compass rose to various plotted courses and bearing lines and vice versa. Parallel rulers are always walked so that the top or lower edge intersects the compass rose center to obtain accurate courses.

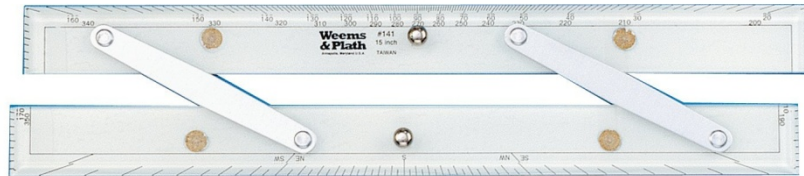

E.3.e. Course Plotter

A course plotter may be used for chart work in place of the parallel rulers discussed above. It is a rectangular piece of clear plastic with a set of lines parallel to the long edges and semi-circular scales. The center of the scales is at or near the center of one of the longer sides and has a small circle or bull's eye. The bull's eye is used to line up on a meridian so that the direction (course or bearing) can be plotted or read off of the scale. A popular model is the "Weems Plotter" that is mounted on a roller for ease of moving.





### E.4. Finding Latitude of a Position

The drafting compass is an instrument similar to the dividers. One leg has a pencil attached. This tool is used for swinging arcs and circles.

To find the latitude coordinate of a position, use a drafting compass or navigators' dividers, and the scale markings on the side of the nautical chart. Follow these instructions in **Figure 3-50** to determine the latitude of a randomly chosen position marked point A. Notice position A is above the solid black horizontal latitude line.

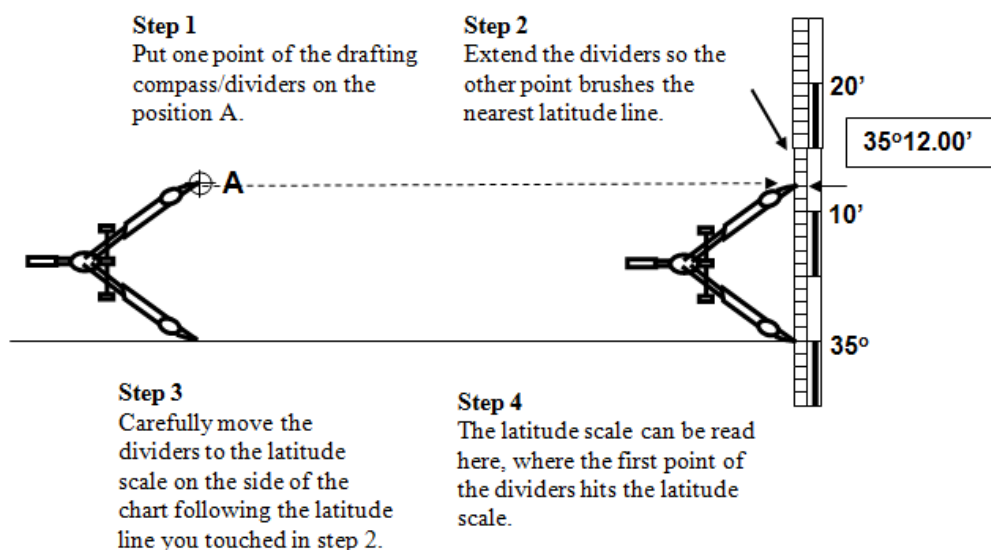

**Figure 3-50**  
**Finding Latitude of a Position**

Notice that latitude is recorded with the degrees number 35 with the degrees (°) symbol, and the minutes of latitude number 12.0 is written with the minutes (') symbol. In this example, the 12.0 has a decimal point followed by 0. This shows that this scale is in tenths of a minute. But when there is no tenths of a minute zero is recorded. If there is no tenths or hundredths of a minute fill in this space with zeros.

The above final position above would read: 35° 12.00' N



To find latitude of a position below the latitude line, use the drafting compass/dividers and follow the instruction in **Figure 3-51** to determine the latitude of a randomly chosen position marked Point B. Notice position B is below the solid black horizontal latitude line.

To find latitude of a position below the latitude line, use the drafting compass/dividers and follow the instruction in Figure 7 to determine the latitude of a randomly chosen position marked Point B. Notice position B is below the solid black horizontal latitude line.

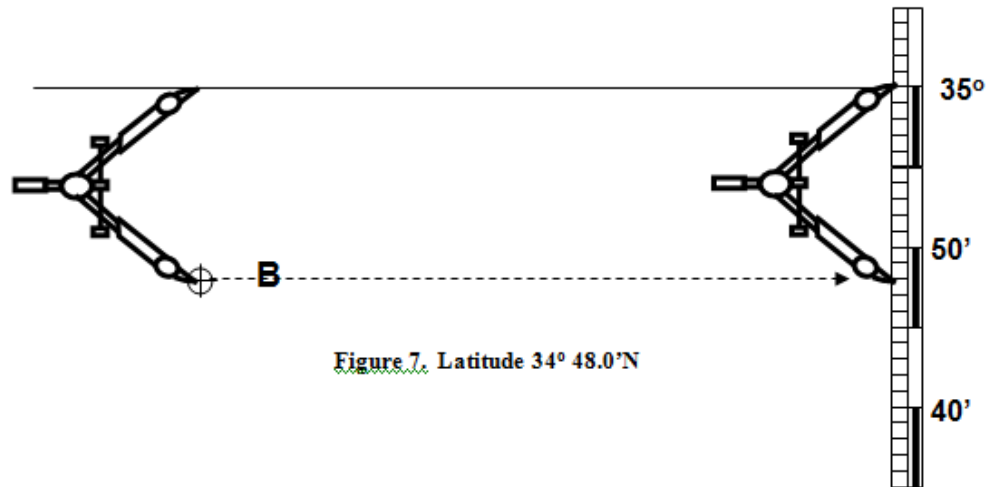

Figure 7. Latitude 34° 48.0'N

Figure 3-51  
Finding the Latitude of a Position (Cont)

**NOTE** 

In this situation it is easier to place one point of the dividers on the line above the position and drop the other point down.

Be sure to read the latitude scale correctly, in this case the latitude is 34° 48.00'N.



**E.5. Finding the Longitude of a Position**

To find longitude of a position, follow the same steps as for latitude described in Paragraph E.4., but using the longitude scale (see **Figure 3-52**).

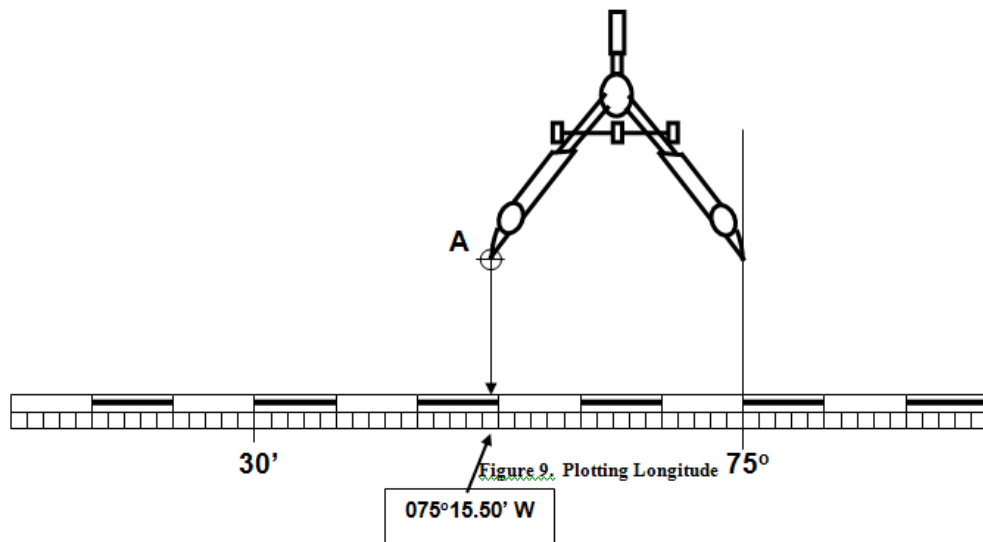

**Figure 3-52**  
**Finding the Longitude of a Position**

Be sure to read the longitude scale correctly, in this case the longitude is 075°15.50'W.



## Minutes and Conversion

### E.6. Degrees, Minutes, Seconds Scale

In the examples provided on the previous pages, a position was identified using degrees, minutes and tenths of minutes. There is another type of scale used to record latitude on a nautical chart. This other scale follows the concept of time. Like time of the day, we have minutes and seconds of time.

This other scale incorporates degrees and minutes and seconds into the scale on the side of the chart. But instead of talking about measuring the difference of the time of day we are now talking about measuring the difference of distance on Earth. To measure the distance on Earth we will use an arc. An arc is a line segment located on a sphere. The line is called latitude and the sphere is called Earth.

<b>1° (one degree)</b>	<b>60' (sixty minutes of arc)</b>
<b>1' (one minute of arc)</b>	<b>60" (sixty seconds of arc)</b>

Use conversions to determine tenths of a minute. One tenth (0.1) of a degree is 60 minutes. One tenth (0.1) of a minute is 6 seconds.

This is important to remember as some charts are measured in degrees, minutes, and tenths of minutes. Other charts are measured in degrees, minutes and seconds.

Below is an example of how each is written:

(01) 35 degrees (°), 27 minutes and 6 tenths of a minute (') North is: 35° 27.6' N.

Notice the decimal point marking the tenths of minutes.

(02) 35 degrees (°), 27 minutes ('), and 36 seconds (") North is: 35° 27' 36" N.

Notice no decimal point, and the symbol " is used.

Although written differently these two examples are marking the exact same position on a nautical chart.

---



---

**E.7. Convert  
Decimal Degrees**

Often individuals using handheld GPS units built for shore-based equipment will report their position in decimal degrees.

To convert the number of minutes to a decimal value, use the following formula:

$$\text{Decimal value} = \text{Minutes}/60$$

As an example, latitude of 122 degrees 45 minutes North is equal to 122.75 degrees North.

To convert Seconds to decimals, divide by 3600.

$$\text{Decimal value} = \text{Seconds}/3600$$

As an example, latitude of 122 degrees 45 minutes 45 seconds North is equal to 122.7625 degrees North.

The complete formula is as follows:

$$\text{Decimal value} = \text{Degrees} + (\text{Minutes}/60) + (\text{Seconds}/3600)$$

---

**Distance and Bearings**

**E.8. Distance**

The separation of two points measured by the length of a straight line joining the points without reference to direction is known as distance. In maritime navigation, it is measured in miles or yards. There are two different types of miles used:

- (01) Nautical miles,
- (02) Statute miles.

---

**E.8.a. Nautical  
Mile**

The nautical mile is a unit of distance used in navigating at sea. It is nearly equal to one minute of latitude. There are approximately 2,025 yards in a nautical mile. The unit of 2,000 yards is used internationally as the accepted distance of the nautical mile. For most purposes, considering the nautical mile the length of one minute of latitude introduces no significant error.

---

**E.8.b. Statute  
Mile**

The statute mile is used mainly on land, but it is also used in piloting inland bodies of water such as the Mississippi River and its tributaries, the Great Lakes and the Atlantic and Gulf Intracoastal waterways.

---





E.8.c. Scales

The distance measured on a chart directly correlates with the scale of the chart (e.g. 1:5000 chart, 1:40,000, 1:80,000). Each chart will depict distance measurements which correlate to its scale or size.

Measuring distance can be done by using the latitude scales on the left and right sides of the chart, or by the graphic scales found on the top or bottom of the chart. Not all charts depict the graphic scale and this is due to the scale of the chart in use, as mentioned above. Charts smaller than 1:80,000 scale do not have a graphic scale. On such charts latitude is your only option to measure distance.

**Figure 3-53** shows the different latitude scales you might find on a chart. The measurements are different due to the scale of the respective chart. The scale of the chart is labelled at the bottom for comparison purposes. The latitude for measuring distance is on the left and right side of the chart.

**CAUTION!**

The longitude scale is never used for measuring distance because the distance between each degree of longitude decreases as you move away from the equator.

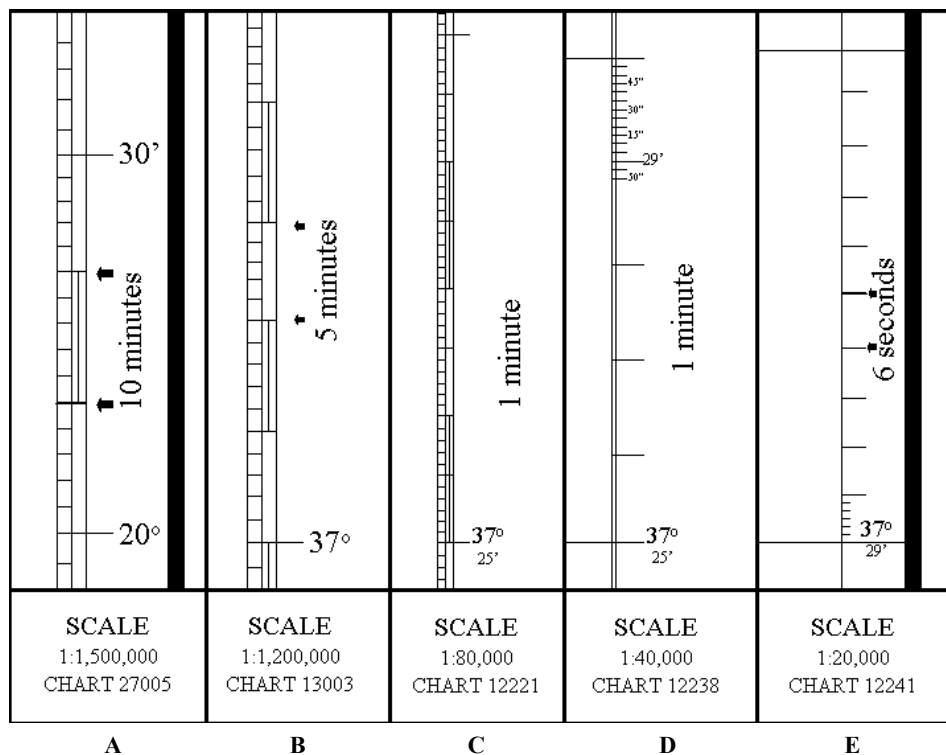

**Figure 3-53**  
**Chart Scales**

- A.** Sailing chart in small scale (large area) divided in degrees and subdivided into minutes. The 10 minutes represents 10 nautical miles.
- B.** Sailing chart in small scale (large area) divided in degrees and subdivided into minutes. The 5 minutes represents 5 nautical miles.
- C.** Coastal chart in small scale (large area) divided in degrees and subdivided into 1 minute, and subdivided again into 10ths of minutes. The 1 minute represents 1 nautical mile.
- D.** Harbor chart in large scale (small area) divided in degrees, minutes, and seconds. The 1 minute represents 1 nautical mile.
- E.** Harbor chart in large scale (small area) divided in degrees, minutes, and seconds. The six seconds represents approximately 600 feet or 200 yards, which is also the same as .1NM.



E.8.d. Measuring  
Distance Using  
Latitude

Latitude is measured between the horizontal lines along a meridian; the length of 1 minute of latitude is the same as 1 nautical mile or 2,000 yards anywhere on the latitude scale.

Care should be taken to measure the distance using the latitude scale in the same general area you are working in on the nautical chart, especially when using sailing charts (small scale covering a large area). The measurement of 1 degree of latitude is not the same on the northern corner of the small scale chart as it is in the southern corner.

Remember, the chart is a flat surface depicting a round surface, so measurements will not be quite exact.

E.8.d.1.  
Measuring  
Distance Using  
Latitude  
Examples

1° of latitude is equal to 60 nautical miles. Look at 0° at the equator in the (Figure 3-54) below.

- (01) **Example 1:** If you travelled from 0° at the equator to 1° north or south latitude, you would have gone 60 nautical miles.  $1^\circ \times 60 = 60$  NM.
- (02) **Example 2:** If you travelled from 0° at the equator to 20° north or south latitude, you would have travelled 1,200 nautical miles.  $20^\circ \times 60 = 1,200$  NM.

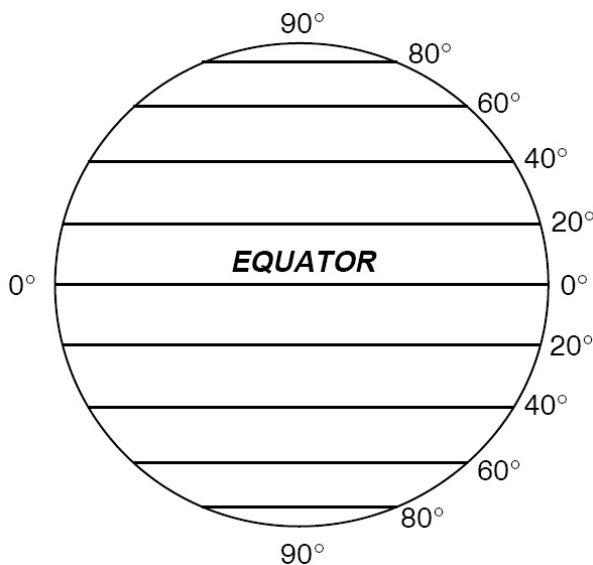

Figure 3-54  
Measuring Distance Using Latitude Example



E.8.d.2.  
Measuring  
Distance Using  
the Latitude  
Scale

Step	Action
1	Place one end of a pair of dividers at each end of the distance to be measured being careful not to change the span of the dividers.
2	Transfer them to the latitude scale closest to the latitude being measured. Read the distance in minutes then convert to NM or yards.

Figure 3-55 relates to steps 1 and 2 above by showing the distance between two lights, transferred to latitude scale.

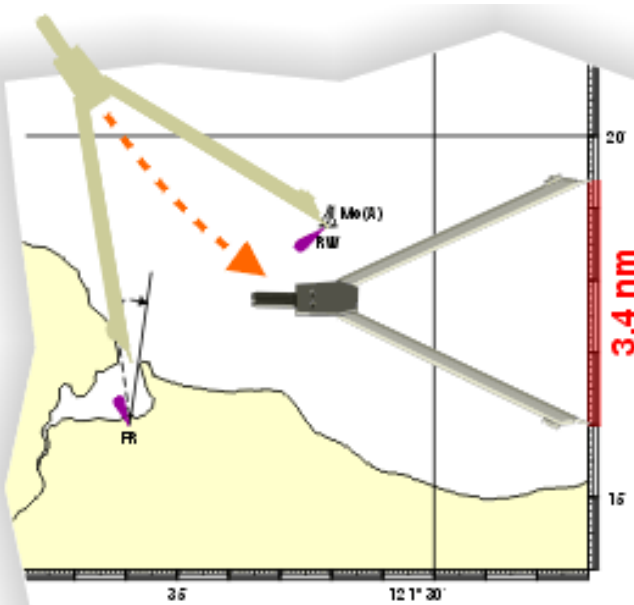

Figure 3-55  
Latitude Scale Distance Measurement

3	When the distance being measured is greater than the span of the dividers, the dividers can be set at a certain distance. Take the known distance and starting at the first point continue marking on your line, and then total the distance (Figure 3-56).
---	---

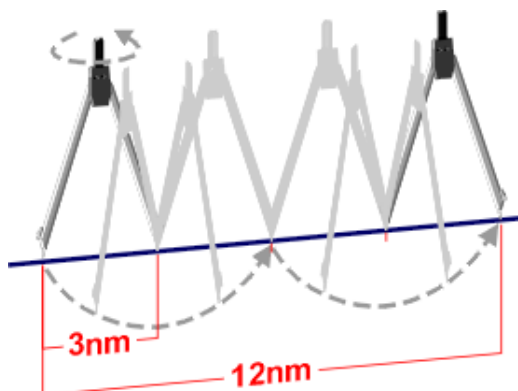

Figure 3-56  
Marking Distance



4	The last span of the measurement, if not equal to that setting on the dividers, must be separately measured. To do this, step the dividers once more, closing them to fill the distance.
5	Measure the distance on the scale and add it to the sum of the other measurements.
6	The latitude scale nearest the middle of the line to be measured should be used.

E.8.e. Measuring Distance Using Graphic Scale

If provided, the graphic scale is found on the top and bottom of the charts. It will provide you with both nautical miles and yards. The top scale is for measuring nautical miles and the bottom is used for measuring yards. Either NM or Yards can be used, depending on the unit of measure you desire.

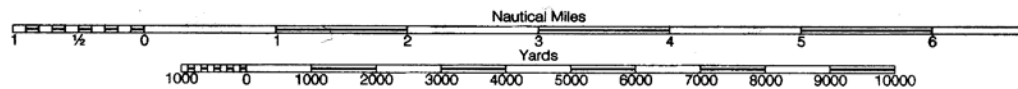

**Figure 3-57**  
 Graphic Scale

Using a compass, place the pointed end on the large number to the right, and the lead will fall in the section on the left, which is broken down in smaller units. Read the large number on the right and add the additional miles/yards from the left.

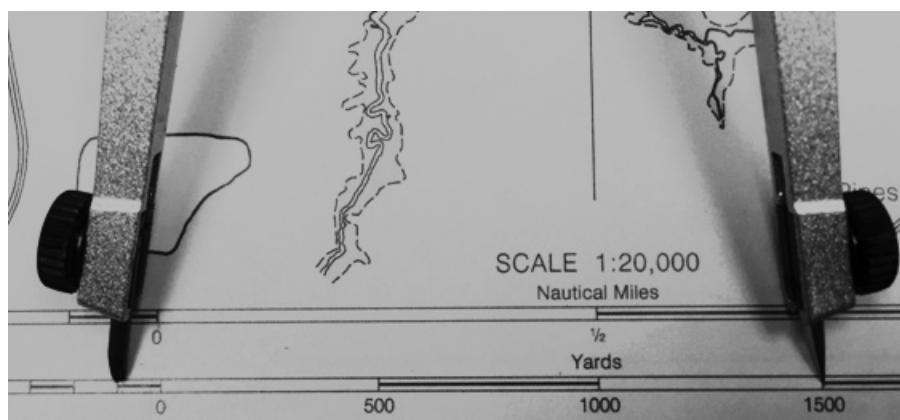

**Figure 3-58**  
 Graphic Scale Distance Measurement



### E.9. Lines of Position

Bearings are obtained primarily by using a magnetic compass (compass bearings) or radar (relative bearings). Bearings of fixed, known, objects are the most common sources for LOPs in coastal navigation. When using a compass to take bearings, the object should be sighted across the compass.

To begin fixing position with this information the bearing to the object is recorded, converted to magnetic or true direction as needed, and plotted. The line drawn on the chart is called a Line of Position (LOP). A single observation gives an LOP, not a position, meaning all that is known is the boat is located somewhere along that LOP.

For example, if a standpipe and a flagstaff in a line are observed, the boat is somewhere on the line drawn from the standpipe through the flagstaff and towards the boat. This line may also be referred to as a visual range (**Figure 3-59**).

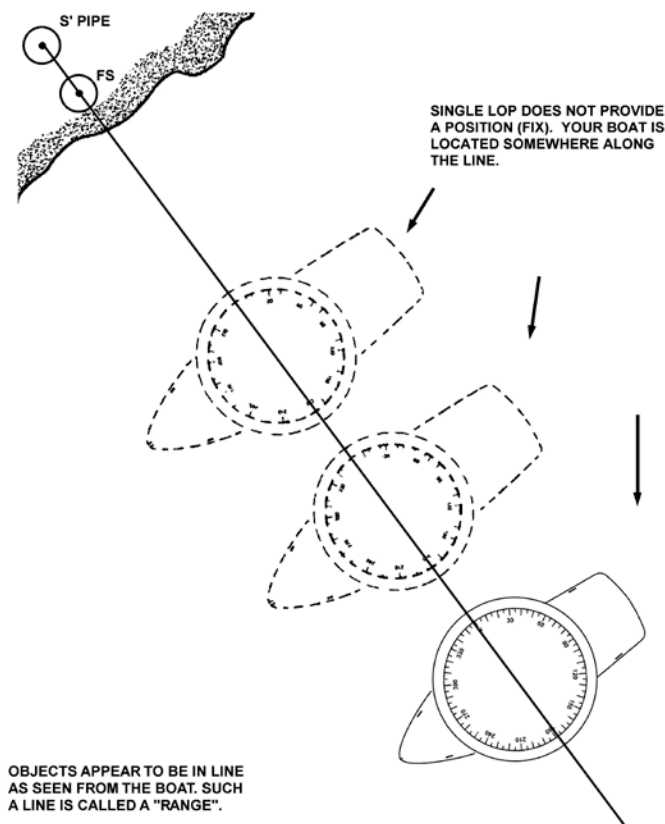

Figure 3-59  
Line of Position



E.9.a. Plotting  
 LOP

One common method of plotting bearings on a chart is using parallel rulers or a course plotter. Follow the example below for plotting the bearing onto the chart.

The boat is on a heading of  $192^\circ$  compass. At 1015, a bearing of  $040^\circ$  relative on a water tower is obtained. Deviation (from the boat's deviation table) on the boat's heading is  $3^\circ$  W.

Step	Procedure
1	Correct the compass heading of $192^\circ$ to the magnetic heading. Write down the correction formula in a vertical line. $C = 192^\circ$ $D = 3^\circ$ W (+E, -W when correcting) $M = 189^\circ$ $V =$ not applicable to this problem $T =$ not applicable to this problem
2	Compute the information opposite the appropriate letter in step 1. Subtract the westerly error, $3^\circ$ W deviation from the compass heading ( $192^\circ$ ) to obtain magnetic heading ( $189^\circ$ ).
3	Add the relative bearing ( $040^\circ$ ) to the magnetic heading ( $189^\circ$ ) to obtain the magnetic bearing ( $229^\circ$ ). $189^\circ$ (M) $+ 040^\circ$ $229^\circ$ magnetic bearing
4	Place the parallel rulers with their edge passing through the crossed lines at the center of the compass rose and the $229^\circ$ mark on the inner ring (magnetic) of the compass rose. (Fig 14-59)
5	Walk the parallel rulers to the dot marking the exact position of the water tower.
6	Draw a broken line and intersect the course line (C $189^\circ$ M).
7	Label a segment of line with the time of the bearing along the top. The segment is drawn near the course line, not the entire length from the water tower.
8	Below the line, label the magnetic bearing $229^\circ$ M.



At 1015, the boat was somewhere along the LOP. A single line of bearing gives an LOP but the boat's location cannot be accurately fixed by a single LOP.

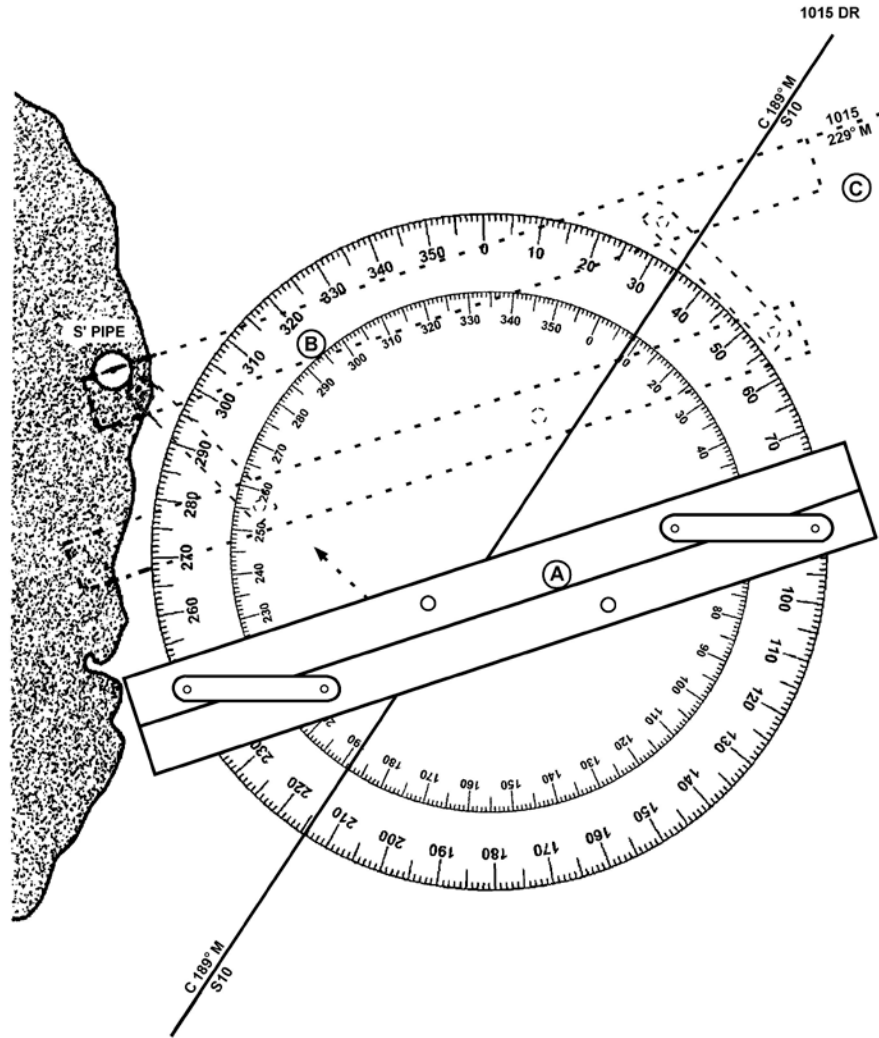

Figure 3-60  
Plotting LOP

## Fixes

### E.10. GPS Fix

Latitude and longitude provided by installed equipment displayed on an electronic chart or plotted on a paper chart, confirmed by depth sounding.





## E.11. Radar Fixes

Radar navigation provides a means for establishing position when other methods may not be available. A single prominent object can provide a bearing and range for a fix, or a combination of bearings and ranges may be used. Whenever possible, more than one object should be used. Radar fixes are plotted in the same manner as visual fixes. Accepted radar fixes include:

The intersection of radar range lines of position, determined using the radar's Variable Range Marker (VRM) function, from three or more prominent points of land or charted fixed objects with a separation of at least 15 degrees, confirmed by a depth sounding.

The intersection of radar bearing lines of position, determined using the radar's Electronic Bearing Line (EBL) function, from charted, fixed objects, confirmed by a depth sounding.

Fixing a boat's position by radar is known as a three point fix as it measure the bearing (direction) and/or range (distance) from three landmarks. The line of sight or distance between a boat and each landmark can be represented as a pencil mark on a paper chart by drawing a line along a measured bearing or measuring distance. The only place a boat can be on one such lines simultaneously is the point at which they cross.

When three lines are involved they should all cross at a single point, but in practice they rarely do, instead forming a triangle. The boat's position is then considered to be on the point or in the center of the small triangle. A large triangle is an indication than an inaccurate measurement was taken. For a fix to be accurate, LOPs and ranges must be observed simultaneously.

### NOTE

For a fix to be accurate, LOPs must be from simultaneous observation. Two or more bearings taken one after the other are considered simultaneous.

#### E.11.a. Selecting Objects for a Radar Fix

The primary consideration in selecting charted objects to obtain a radar fix is the angle between the objects. Attempts should always be made to take bearings or rangers on objects as close as possible to the boat because minor errors in readings are magnified when increasing distance from the object.

When there are only two LOPs or ranges for a fix, the quality of the fix will be best when there is a 90° difference in the lines. Serious error in position could result if a difference of less than 60° or more than 120° between the two lines exists. Therefore, two LOPs should intersect at right angles or near right angles wherever possible.

An ideal fix has three or more LOPs intersecting at a single point and the LOPs have a separation of at least 60°, but not more than 120°.



E.11.b. Order for  
Obtaining  
Bearings

When obtaining radar bearings or ranges, the proper procedure is to shoot the object closest to the boat's beam first because it has the greatest angular velocity relative to the boat and is changing most rapidly.

Objects toward the bow or stern should be shot last because their angle changes more slowly.

**NOTE**

Failure to obtain bearings in the proper order can result in a bad fix.

**NOTE**

An error of 1 degree at 1 mile will result in an error of 100 feet.

E.11.c.  
Obtaining a  
Radar Fix Using  
VRM

At 0215, the boat is on a course of 300° (303° M). The radar range scale is on 12 miles. Two radar contacts (land or charted landmark) are observed. The first has a bearing of 330° relative at 12 NM. This target is on the third range circle. The second target is bearing 035° relative at 8 NM. This target is on the second range circle. Obtain a distance measurement fix (**Figure 3-61**) by performing the following procedures:

**NOTE**

Radar ranges are usually measured from prominent land features such as cliffs or rocks. However, landmarks such as lighthouses and towers often show up at a distance when low land features do not.

Step	Procedure
1	Locate the objects on the chart.
2	Spread the span of the drawing compass to a distance of 12 NM (distance of first target), using the latitude or nautical mile scale on the chart.
3	Without changing the span of the drawing compass, place the point on the exact position of the object and strike an arc towards the DR track, plotting the distance.
4	Repeat the above procedures for the second object (distance of 8 NM). Where the arcs intersect is the fix (position).

**NOTE**

The arcs of two ranges will intersect at two points. In some cases, a third LOP may be needed to determine which intersection represents the fix position.

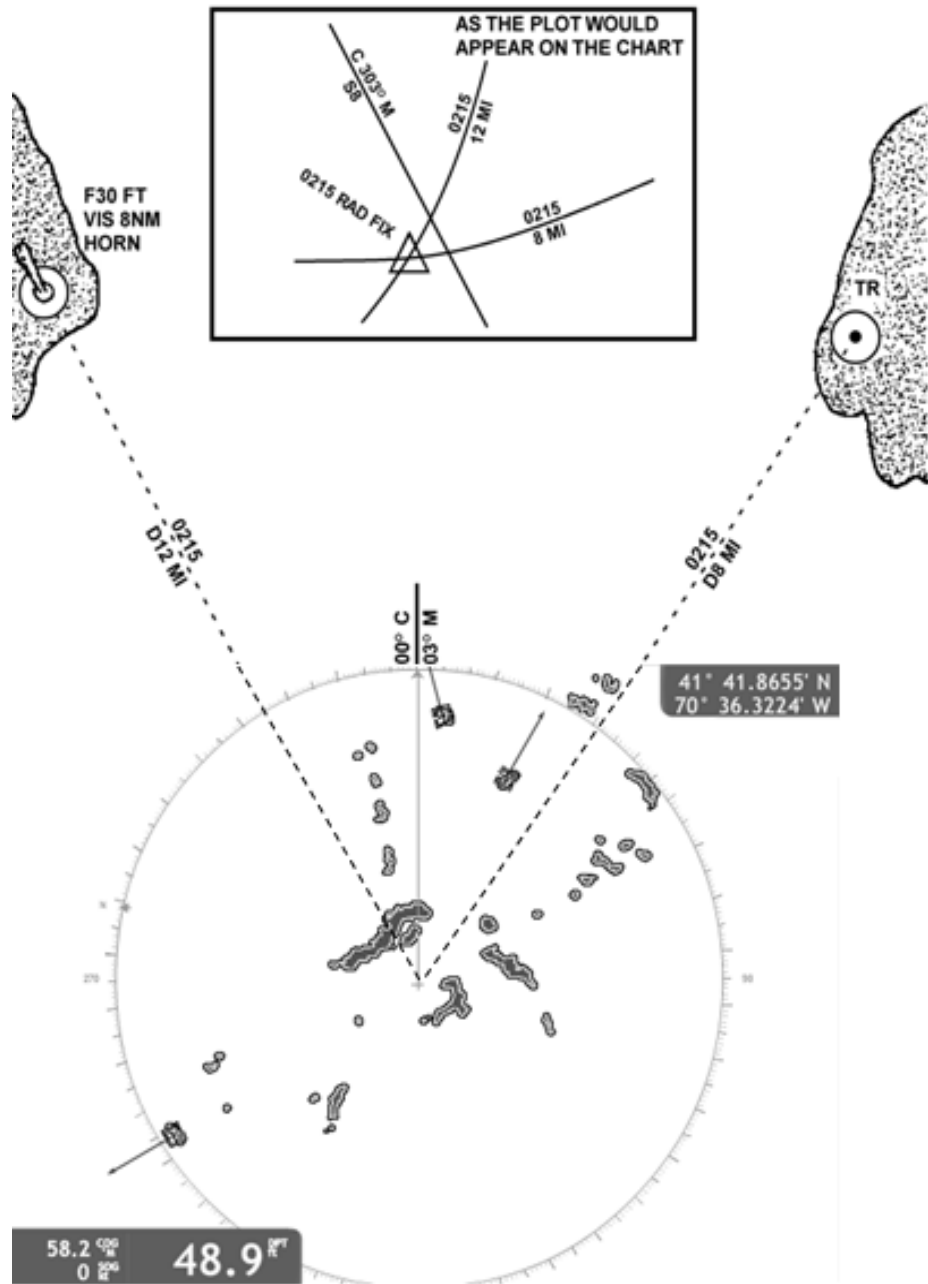

Figure 3-61  
Obtaining a Radar Fix Using VRM



E.11.d.  
Obtaining a  
Radar Fix Using  
Electronic  
Bearing Lines  
(EBL)

Step	Action
1	Locate the compass rose nearest your location on the chart.
2	Align a parallel rule on the compass rose for the true or magnetic bearing observed to the object using the radar's EBL.
3	Move the parallel rule over to the chart symbol of the observed object.
4	Draw a reciprocal line from the object on the chart.
5	Repeat steps 2 through 4 for the next objects that were observed.
6	Locate the area where all of the lines of position intersect. Where the arcs intersect is the fix (position).

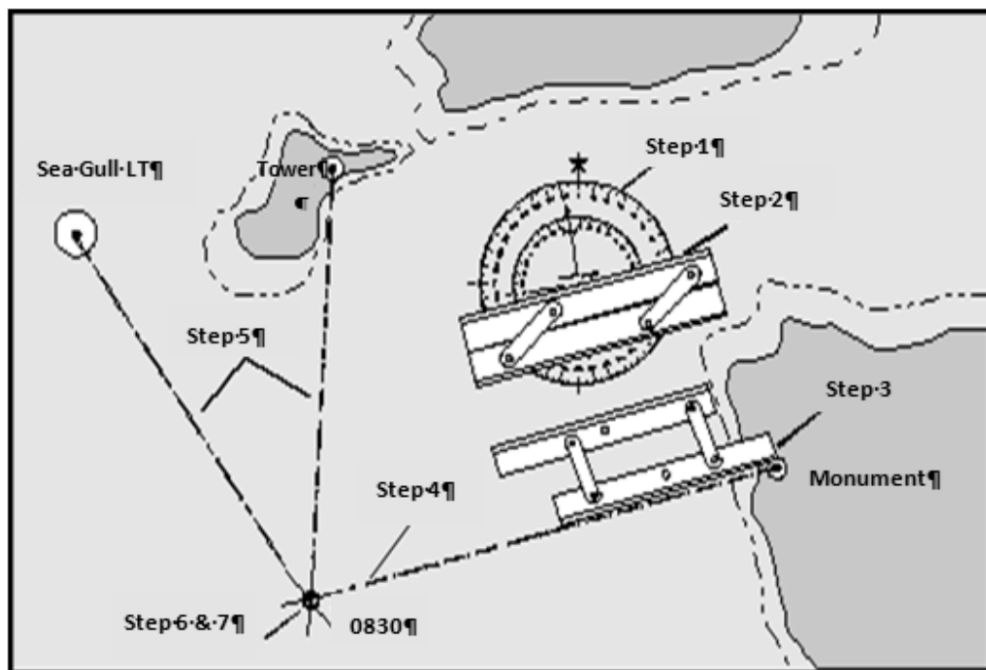

Figure 3-62  
Obtaining Radar Fix Using EBL



E.11.e.  
Combination  
VRM and EML  
Fix

Position cannot be accurately fixed by a single LOP or measured distance (range). Two or more intersecting LOPs or ranges must be plotted to obtain an accurate fix. The greater the number of LOPs or ranges intersecting at the same point, the greater the confidence in the fix. Radar LOPs and ranges may be combined to obtain fixes. Typical combinations include two or more bearings, a bearing with distance range measurement to the same or another object, or two or more distance ranges. Radar LOPs may also be combined with visual LOPs.

### E.12. Visual Fix

Visual fixes are taken using terrestrial ranges and by bearings obtained from sightings across a compass, hand-held bearing compass, or relative bearings measured from 000° at the reference direction clockwise through 360°.

Visual Fixes are plotted in the same manner as radar fixes.

E.12.a  
Converting  
Bearings  
(Relative Plot)

Relative bearings must be converted to true bearings before being plotted. True bearing is the bearing in relation to true north. A true bearing (TB) is obtained by adding the value of the relative bearing (RB) to the ship's heading (SH) at the time the bearing is taken.

$$TB = RB + SH$$

### NOTE

Subtract 360° if the resulting amount is over 360°.

Examples are listed below.

$$(01) \text{ Example 1: (RB) } 090^\circ + (\text{SH}) 280^\circ = (\text{TB}) 370^\circ$$

$$370^\circ - 360^\circ = 010^\circ$$

$$(02) \text{ Example 2: (RB) } 045^\circ + (\text{SH}) 120^\circ = (\text{TB}) 165^\circ$$

E.12.b. Visual  
Fix Using  
Bearings

Fixing a boat's position by visual bearing is known as a three point fix as it measures the bearing (direction) from three landmarks. The line of sight or distance between a boat and each landmark can be represented as a pencil mark on a paper chart by drawing a line along a measured bearing. The only place a boat can be on one such lines simultaneously is the point at which they cross.



When three lines are involved they should all cross at a single point, but in practice they rarely do, instead forming a triangle (**Figure 3-63**). The boat's position is then considered to be on the point or in the center of the small triangle. A large triangle is an indication that an inaccurate measurement was taken. For a fix to be accurate, must be observed simultaneously.

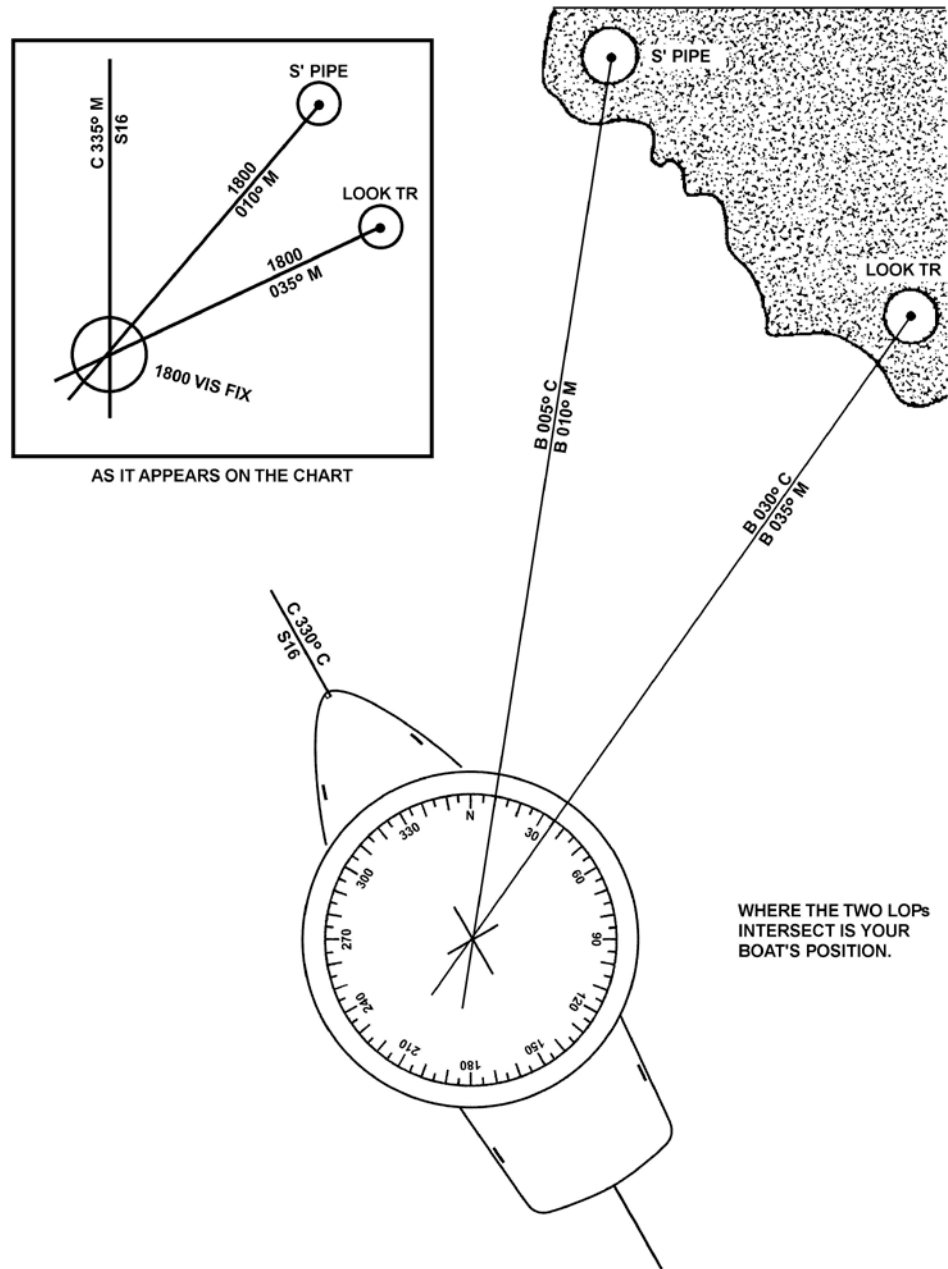

**Figure 3-63**  
**Fix Using Visual Bearings**



E.12.c. Visual  
Fix Using  
Terrestrial  
Ranges

When two charted objects are in a straight line as seen from a boat, the boat is located somewhere on a straight line through these objects. This is known as a visual range. Frequently, a range will mark the center of a channel. The boat is steered so as to keep the range markers in line.

Ranges may be established navigational aids or natural ranges such as a church steeple and a water tower. When entering or leaving a harbor, it is often possible to fix the position by means of ranges.

E.12.c.1.  
Example

While steering on a range (keeping the bow lined up with the two range marks), the time is 0800 when two charted objects (for example, a water tank and smoke stack) line up on the starboard side. The boat's position is at the intersection of the lines drawn through each set of ranges (**Figure 3-64**). After having observed two sets of ranges that determined a fix, a magnetic course of  $000^{\circ}$  M is steered to stay in safe water.

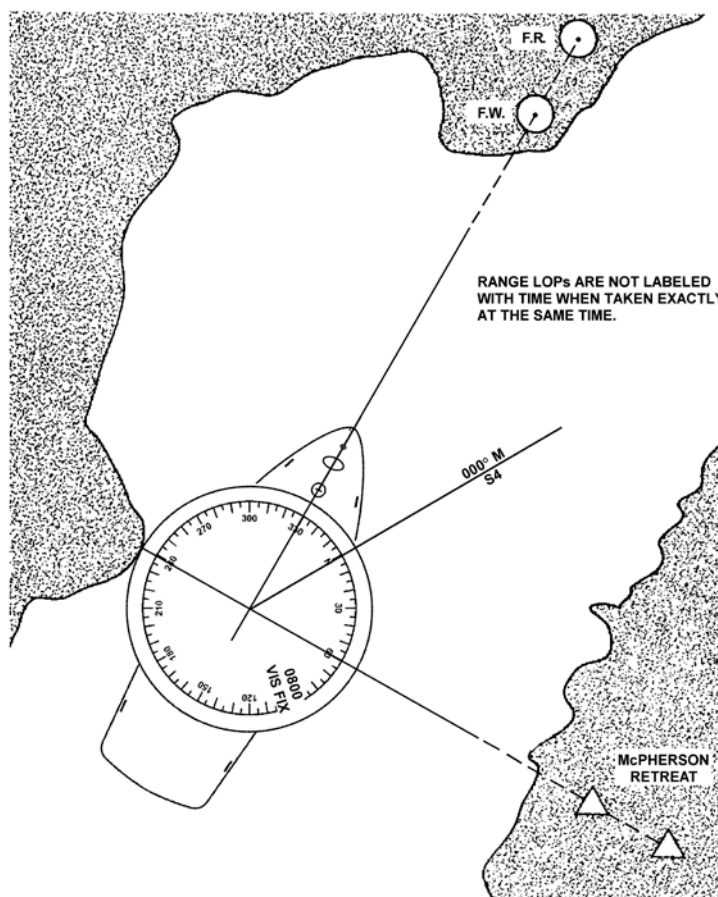

Figure 3-64  
Visual Fix Using Terrestrial Ranges



---

## Section F. Navigation Planning

---

**Introduction** Planning before the start of a voyage or sortie reduces the cognitive and physical workload required for safe navigation, particularly at high speeds where the time available for situation assessment and decision making are limited. Pre-planning for the navigation of regularly travelled waters and for specific known operations will improve the crews' ability to identify and assess situations as they present and overcome any challenges.

---

**In this Section** This section contains the following information:

Title	See Page
<a href="#">Planning Process</a>	3-105
<a href="#">Information Prep</a>	3-106
<a href="#">Plotting Components</a>	3-113
<a href="#">Calculations</a>	3-117
<a href="#">Rules</a>	3-123
<a href="#">Critical Considerations</a>	3-126

---





## Planning Process

**F.1. Navigation Planning Process** A navigation plan, containing waypoints, courses, etc., can be produced to serve as a crosswalk between systems. It can also be used for reference while navigating.

The intended primary means of navigation is not necessarily used as the source of voyage planning. For example, the coxswain may choose to first prepare paper charts, then transfer approved plans to the electronic charting systems. Alternatively, all voyage planning may be conducted within the electronic charting system and then transferred to the back-up paper chart.

On an electronic or paper chart the coxswain plans the route, which encompasses several consecutive lines joined together at waypoints. An individual line is termed the course or leg and the entire collection of courses is termed the route. Where to place a course on the chart is dictated by the position of the intended destination and that of any dangers such as land and shallow waters. Also considered are the crew and the vessel status and the projected environmental conditions.

When all equipment is verified for proper operation, desired alarms are set and activated, and all necessary courses have been entered into electronic systems or drawn on a paper chart and evaluated, the planning is finished and the boat is ready to start navigating. To follow the plan the coxswain must know the boat's position relative to the plan and the remaining distance left until the course has to be changed.

- (01) Complete the primary system navigation preparations.
- (02) Complete back-up system preparations.
- (03) Compare each line of the route plan with the data displayed.

---

## F.2. Defining Boat Specifications

Specify the following navigational information to assist the navigation planning process. This information will determine the minimum depth of water the boat can safely transit, the height of bridges required for unimpeded passage, etc.

- (01) Navigational Draft.
  - (02) Length overall.
  - (03) Vessel Beam.
  - (04) Masthead height (fixed and unfixed)
  - (05) Speed/RPM curve.
-



## Information Prep

**F.3. Publications** When preparing charts and developing navigation or crew briefs, consult currently corrected nautical and hydrographic publications (or the electronic equivalents). Refer to reference (b) for required publications.

### F.3.a. Coast Pilots

The amount of information that can be printed on a nautical chart is limited by available space and the system of symbols that is used. Additional information is often needed for safe and convenient navigation. Such information is published in the [\*Coast Pilot\*](#). These are printed in book form covering the coastline and the Great Lakes in nine separate volumes.

Each *Coast Pilot* contains sailing directions between points in its respective area, including recommended courses and distances. Channels with their controlling depths and all dangers and obstructions are fully described. Harbors and anchorages are listed with information on those points at which facilities are available for boat supplies and marine repairs. Information on canals, bridges, docks, and more, is included. The nine volumes are as follows:

	Volume	Area of Coverage
<b>Atlantic Coast</b>	No. 1	Eastport to Cape Cod
	No. 2	Cape Cod to Sandy Hook
	No. 3	Sandy Hook to Cape Henry
	No. 4	Cape Henry to Key West
	No. 5	Gulf of Mexico, Puerto Rico, and Virgin Islands
<b>Great Lakes</b>	No. 6	Great Lakes and connecting waterways
<b>Pacific Coast</b>	No. 7	California, Oregon, Washington, and Hawaii
<b>Alaska</b>	No. 8	Dixon Strait to Cape Spencer
	No. 9	Cape Spencer to Beaufort Sea



F.3.b. Light List [Light Lists](#) provides more complete information concerning aids to navigation than can be shown on charts. They are not intended to replace charts for navigation and are published in seven volumes, as follows:

<b>Volume</b>	<b>Area of Coverage</b>
I	Atlantic Coast, from St. Croix River, Maine to Toms River, New Jersey
II	Atlantic Coast, from Toms River, New Jersey to Little River Inlet, South Carolina
III	Atlantic Coast, from Little River Inlet, South Carolina, to Econfina River, Florida, and the Greater Antilles
IV	Gulf of Mexico, from Econfina River, Florida, to Rio Grande, Texas
V	Mississippi River System
VI	Pacific Coast and Pacific Islands
VII	Great Lakes

F.3.c. Tide Tables

[Tide Tables](#) give daily predictions of the height of water, at almost any place, at any given time, and are published annually in four volumes. Instructions for using the tables are provided within the publication. The four volumes are as follows:

<b>Volume</b>	<b>Area of Coverage</b>
I	Europe and West Coast of Africa (including the Mediterranean Sea)
II	East Coast of North and South America (including Greenland)
III	West Coast of North and South America (including the Hawaiian Islands)
IV	Central and Western Pacific Ocean and Indian Ocean



F.3.d. Tidal  
Current Tables

[Tidal current tables](#) provide the times of maximum flood and ebb currents, and times of the two slack waters when current direction reverses. They also tell the predicted strength of the current in knots. The time of slack water does not correspond to times of high and low tide. The tide tables cannot be used for current predictions. The tables are published in two volumes. Instructions for using the tables are provided within the publication. The two volumes are as follows:

Volume	Area of Coverage
I	Atlantic Coast of North America
II	Pacific Coast of North America and Asia

F.3.e. Navigation  
Rules and  
Regulations  
Handbook

The Rules of the Road set forth regulations for navigable waters and are covered in the [Navigation Rules and Regulations Handbook](#).

F.3.f. Broadcast  
Notice to  
Mariners (BNM)

Broadcast Notices to Mariners are made by the Coast Guard through Coast Guard and Navy radio stations. These broadcast notices, which are broadcast on VHF-FM, Navigation Telex Radio (NAVTEX), and other maritime frequencies, are navigational warnings that contain information of importance to the safety of navigation. Included are reports of deficiencies and changes to aids to navigation, the positions of ice and derelicts, and other important hydrographic information.

F.3.g. Local  
Notice to  
Mariners (LNM)

The [Local Notice to Mariners](#) is printed by the U.S. Coast Guard Navigation Center, organized by Coast Guard Districts. Temporary changes to aids to navigation, special published announcements, and other important information affecting navigational safety are available on this web site.

F.3.h. Notice to  
Mariners (NTM)

The [Notice to Mariners](#) are published weekly by the National Geospatial-Intelligence Agency (NGA). It contains a listing of chart and publication changes and corrections, as well as broadcast warnings and advisories.

Section I of the NTMs, chart corrections are listed by chart number, beginning with the lowest and progressing in sequence through each chart affected. A correction preceded by a star indicates that it is based on original U.S. source information. If no marking precedes the correction, the information was derived from some other source. The letter “T” preceding the correction indicates the information is temporary in nature and the letter “P” indicates it is preliminary. At times there are temporary corrections that have since been eliminated, hence no duplication of work will be necessary.

The NGA no longer distributes a hard copy version of the weekly Notice to



---

Mariners. Weekly Notice to Mariners is available online and free of charge.

---

#### F.4. Electronic Chart Selection

Determine the best available chart data source for intended voyage and loaded into the navigation system. The operator can control certain settings and functions, some of the most important of which are the parameters for alarms and indications (cross-track error, safety contour, etc.).

#### NOTE

Verify chart datum matches corresponding paper chart. If they do not match and a better scale chart is unavailable, ensure to note the difference on the electronic chart and/or paper chart.

#### F.4.a. Electronic Chart Preparations

Consult electronic chart and information products applicable to the intended route or AOR to ensure all available updates and precautions for the route or area are accounted for. If system allows mark hazards.

---

#### F.5. Paper Chart Selection

Choose the largest scale chart available. Often, transits will be too long to be represented on only one chart. Therefore, obtain all the charts required to cover the entire passage. Using the NTM, verify that these charts have been corrected through the latest Notice to Mariners. Check the LNM and the BNM file to ensure the chart is fully corrected. Annotate on the chart or a chart correction card that all the corrections have been made. This will make it easier to verify the chart's correction status prior to its next use. The following link will provide more information.

<http://www.charts.noaa.gov/InteractiveCatalog/nrnc.shtml>

Correct chart selection and preparation is the foundation on which safe piloting is based. Correct chart selection requires a combination of skill and judgment. Here are some questions to consider when selecting charts and preparing them for restricted water transit.

- (01) Has the best scale chart(s) been selected for the given area?
  - (02) Are the latest editions of selected charts available and corrected up-to-date?
  - (03) Is shoal water clearly identified on the chart?
  - (04) Are the desired tracklines laid out on the chart?
  - (05) Ensure all hazards to navigation along the tracklines are identified and marked.
  - (06) If needed, all turn bearings and turn ranges are marked on all the turns.
- 

#### F.5.a. Paper Chart Corrections

Paper charts are considered to be up-to-date if they are both the most current edition and corrected up to the latest [Local Notice to Mariners](#), Weekly Notice to Mariners, and Broadcast Notice to Mariners.

Mariners using traditional paper charts apply chart corrections manually by using pencils, erasers, rulers, compasses, dividers, and protractors.



**NOTE** 

Do not use red ink for any navigation charts or publications corrections. It will not be visible at night when utilizing a red lens light such as a chart light.

F.5.b. Print on Demand

NOAA produces a [print on demand \(POD\)](#) charts. It is a paper chart that is printed at the time of purchase and contains chart updates up until the time of purchase. If the mariner chooses to purchase a POD chart, all updates that have been published in the one year between the new edition date and the purchase date have already been applied.

F.5.c. Working the Corrections

When pulling out the most recent edition of any chart or product and wanting to make it ready for use, start with the most recent NTM correction and work backwards to the oldest for that edition to that chart or product. Many corrections are temporary. If you start with the most recent, any aid to navigation that was temporary put in place may now be taken out of service again and not requiring any work for that specific NTM.

F.5.d. Small Corrections

Corrections such as buoy changes/additions, addition of a new sounding, restricted areas, fish havens, wrecks, etc., should be done with pen and ink. Use your compasses, find the exact latitude and longitude, and then make the correction, using the symbols from Chart No. 1, as your guide. Chart No. 1 encompasses all corrections you will have to make to charts, with the exception of Tidal/datum changes, such as mentioned above. Most current edition of Chart No.1 is in electronic format only. A chart correction template is best for use in making the corrections look like the rest of the chart.



F.5.e. Recording Corrections

After making corrections to the charts, it must be recorded. There are two (2) methods used to do this. The first way that must be done is to make a cross on the bottom left hand corner of the chart (**Figure 3-65**), having the LNM and NTM number and date (year on one side and the initials of the person making the correction on the other side). The other place to record a pen and ink or cut and paste correction may be on a Correction Card (**Figure 3-66**).

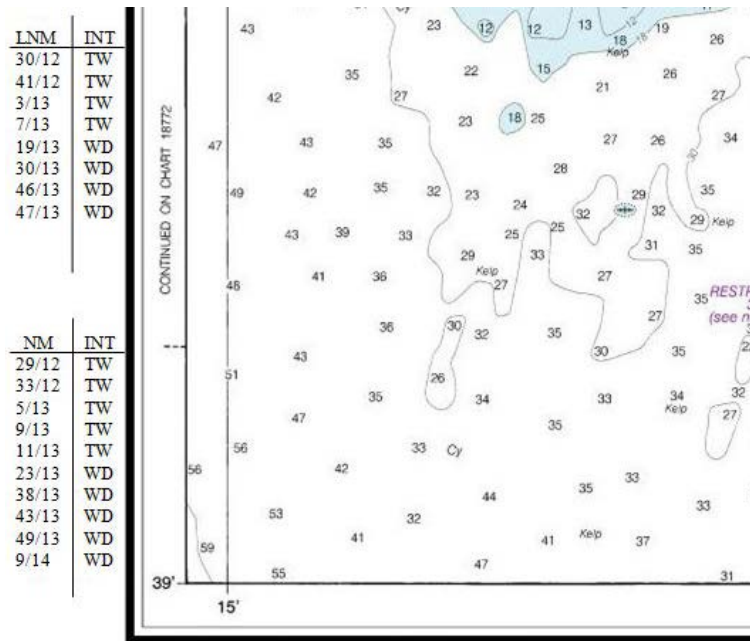

**Figure 3-65**  
**Chart for Correction**

CHART/PUB. CORRECTION RECORD					NIMA FORM 8660-9, MAY 98			REPLACES DMA FORM 8660-9, JUN 95							
CHART/PUB.NO.	PORTFOLIO NO.	EDITION NO./DATE	CLASS	PRICE	CORRECTED THRU N. TO M. NO./YEAR OR PUB CHANGES										
TITLE															
APPLICABLE NOTICE TO MARINERS															
NM	PUBS. PAGE NO.	CORRECTION MADE		NM	PUBS. PAGE NO.	CORRECTION MADE		NM	PUBS. PAGE NO.	CORRECTION MADE		NM	PUBS. PAGE NO.	CORRECTION MADE	
		DATE	INITIAL			DATE	INITIAL			DATE	INITIAL			DATE	INITIAL
CHART/PUB. NO															

**Figure 3-66**  
**Chart/Pub. Correction Record Card**



F.5.f. Hazards to Navigation

Although the charts you have on board may now be corrected and up to date according to the NTM's and LNM's, continue to use caution when navigating. Never take shoal areas or other hazard's closer aboard than necessary because they may not be exactly where they are charted. Some of the hydrographic surveys on even today's charts may be many years old, and have incorrect information. As well, some hazards have a tendency to move through the water. Some aids to navigation can become hazards for this same reason.

After the charts have been selected and corrected according to the LNM and NTM, the next process is to identify and mark the hazards to navigation associated with each part of the transit.

To mark hazards, proceed as follows

<b>Step</b>	<b>Action</b>
1	Confirm the navigational draft for the boat.
2	Using a BLUE marker, mark the contour line corresponding to the navigational draft.
3	Mark other hazards as required: (01) Submerged obstructions (wrecks, rocks, shoals), (02) Stone embankments (rip-rap) around navigation aids, (03) Channel restrictions etc., (04) Other shallow spots.





## Plotting Components

**F.6. Waypoints** A waypoint is a location. It can be a starting point, destination point, or any point in between. Typically organizations maintain a list of regularly visited points of interest, sometimes referred to as a waypoint bank.

On paper charts a waypoint is plotted as a latitude and longitude and may be labeled with a solid dot and a circle, normally coupled with the letters WPT and a number (e.g. WPT001).

Electronic Charting Systems (ECS) or Electronic Chart Display and Information Systems (ECDIS) will allow the entry of waypoints as coordinates of latitude and longitude, or the selection of waypoints by moving a cursor around on the charts. Most systems today allow for hundreds of waypoints to be entered and stored. Waypoints entered into electronic systems are simplistic in the sense that if you are at point A and want to navigate to point B, the waypoint for point B will be calculated based on the shortest distance. The down side to this is the course offered may be over land, shallow water, etc. Always make sure to check for hazards along your track. Some navigation systems have an alarm that lets you know the course is over land where others do not.

It is a good idea to make sure that all waypoints that make up a route are validated before using them. Some things you can do to help avoid mistakes are:

- (01) Use pre-approved waypoints whenever possible.
- (02) When possible, enter waypoints at the dock versus underway. This will likely make for more accurate entry of new waypoints and routes.
- (03) Have someone else double-check them for accuracy.
- (04) Check your course with expected AtoN and landmarks you should be seeing.

---

### F.6.a. Labelling Waypoints

Waypoints are routinely labeled with a cross formed by the intersection of your compass arcs (**Figure 3-67**).



**Figure 3-67**  
**Waypoint**

---



## F.7. Tracklines

A trackline is your intended course plotted on a paper or electronic chart. The purpose of a trackline is to provide a graphic representation of a vessel's intended route. The trackline defines the direction in which the vessel will travel between waypoints to arrive at its intended location at a predetermined time (Figure 3-68). A trackline should not be mistaken for a course line. A course line is your actual course you are steering either magnetic or true to maintain your vessel on the trackline. Tracklines and principal navigation routes should be established for commonly transited areas.

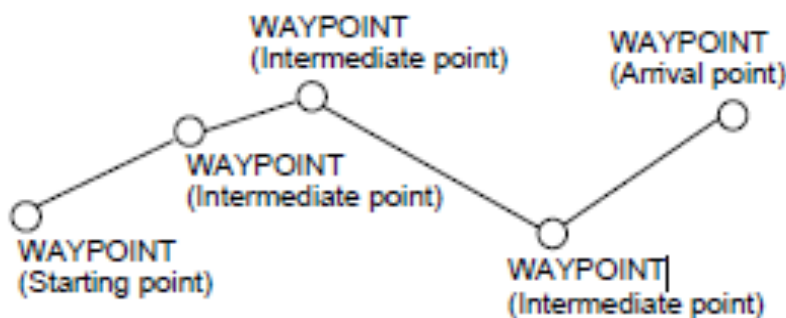

Figure 3-68  
Sample Trackline/Route

When creating tracklines, consult the Fleet Guide and Sailing Directions for recommendations on the best track to use. Look for any information or regulations published by the local harbor authority. Lacking any of this information, locate a channel or safe route on the chart and plot the vessel's track. Most U.S. ports have well-defined channels marked with buoys. Carefully check the intended track to ensure a sufficient depth of water under the keel will exist for the entire passage. If the scale of the chart permits, lay the track out to the starboard side of the channel to allow for any vessel traffic proceeding in the opposite direction. Many channels are marked by natural or man-made ranges. Not only are ranges useful in keeping a vessel on track, they are invaluable for determining gyro error.

When creating and review tracklines be aware of all aerial objects (bridges, power lines, etc.) that may not meet the vertical clearance of the tallest point of the vessel.

Electronic Charting System (ECS) or Electronic Chart Display and Information System (ECDIS) will allow the creation and storage of numerous pre-defined routes, which can be combined in various ways to create complex voyages.

## F.8. Laying the Trackline

Courses between waypoints create tracklines to steer from the beginning point to arrival at the destination.



Electronic charting systems and GPS units allow users to construct routes in a variety of ways including by cursor and using stored waypoints. Consult the equipments' manual for specific directions.

The technique for laying each course line (**Figure 3-69**) on a paper chart is the same and is summarized as follows:

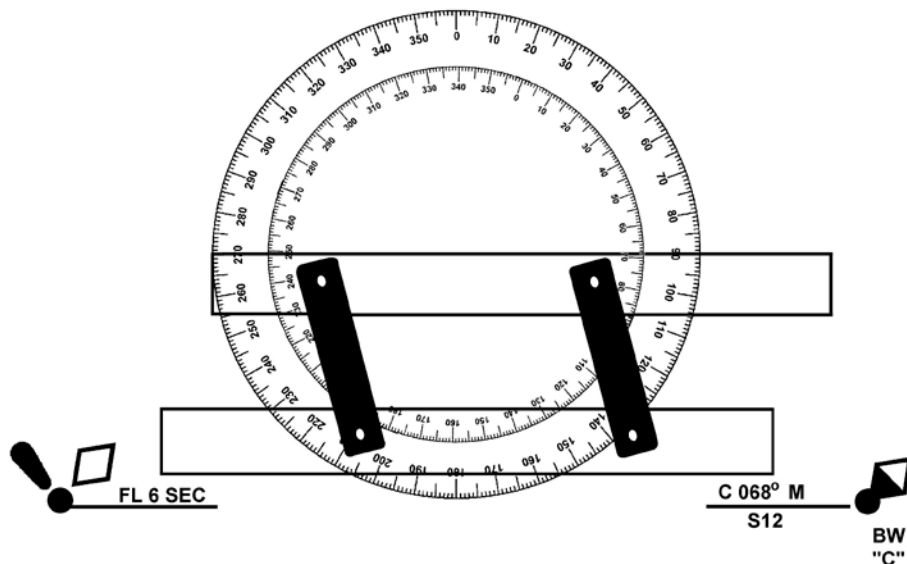

**Figure 3-69**  
 Laying Trackline

Step	Procedure
1	Draw a straight line from the departure point to the intended destination. This is the course line.
2	Lay one edge of the parallel rulers along the course line.
3	Walk the rulers to the nearest compass rose on the chart, moving one ruler while holding the other in place.
4	Walk the rulers until one edge intersects the crossed lines at the center of the compass rose.
5	Going from the center of the circle in the direction of the course line, read the inside degree circle where the ruler's edge intersects. This is the magnetic course (M).
6	Write the course along the top of the pencilled trackline as three digits followed by the letter (M) magnetic, for example, C 068° M. <b>Figure 3-69</b> shows a course of 068° M between two buoys as measured by parallel rulers on a chart's compass rose.



F.8.a. Labelling  
Tracklines

Plot tracklines as a bold line to ensure ready identification of intended track. Label each tracklines with True and Magnetic courses for both departure and return and the distance of each track in nautical miles (NM) and yards (YDS) (Figure 3-70).

Labeling of courses and distances should be far enough away from the trackline to avoid interfering with navigable waters, preferably in shoal water areas, or areas that will not likely be used for transit.

Below are various methods of identifying courses & distances on your charts.

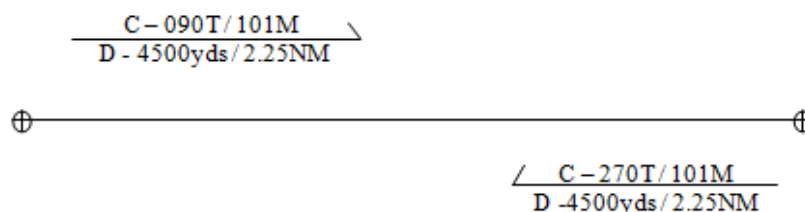

Figure 3-70  
Labeling Tracklines

F.9. Turn  
Bearing / Range

A turn bearing is a predetermined bearing to a charted object from the track point at which the rudder must be put over in order to make a desired turn. In selecting a navigational aids (NAVAID) for a turn bearing, find one as close to abeam as possible at the turning point, and if possible on the inside elbow of the turn. The distance the vessel moves along its original course from the time the rudder is put over until the new course is reached is called advance. The distance the vessel moves perpendicular to the original course during the turn is called transfer. Account for advance and transfer and label the bearing to the nearest 0.1°. A turn range is similar, but taken as a radar range to a prominent object ahead or astern. Ideally, both can be used, one as a check against the other. Figure 3-71 shows turn bearings/ranges.

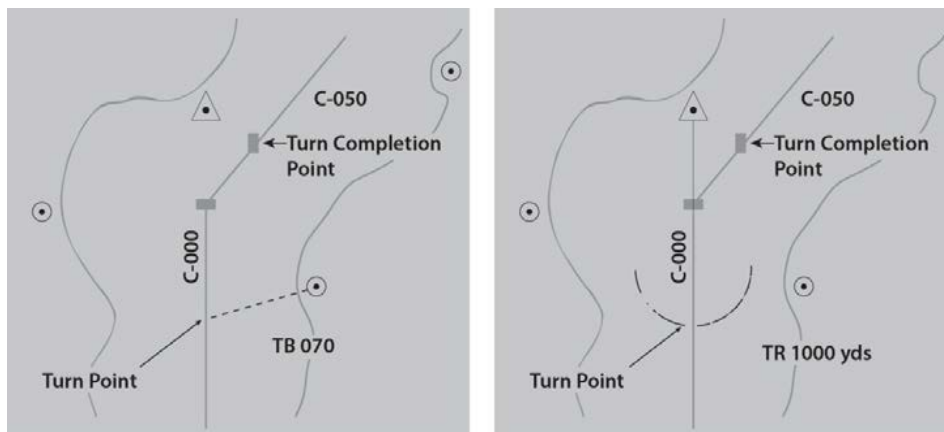

Figure 3-71  
Turn Bearing / Range



### F.10. Danger Bearing/Range

Danger bearings are the maximum or minimum bearing of a point for safe passage of an off-lying danger. Danger bearings are placed on a nautical chart to show a bearing from the boat to an object. As a vessel proceeds along a coast, the bearing of a fixed point on shore such as a lighthouse is measured frequently. As long as the bearing does not exceed the limit of the predetermined danger bearing, the vessel is on a safe course. They are used to warn the vessel if it may be approaching a hazard too closely. Danger bearings are plotted with a no less than (NLT) or no more than (NMT) bearing line. Hash marks indicate the hazard side of danger bearing.

Danger ranges are used in the same manner as danger bearing. NLT or NMT yards are plotted from an object indicating a safe distance from a hazard. **Figure 3-72** shows danger bearings/ranges.

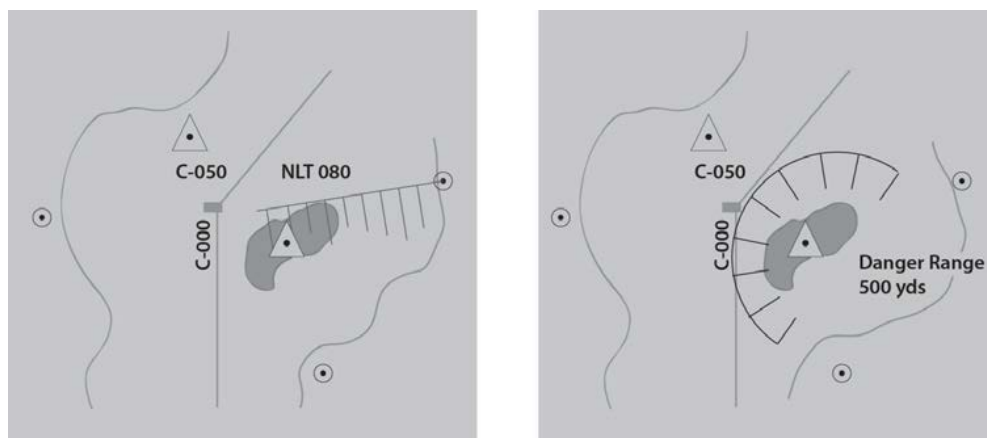

Figure 3-72  
Danger Bearing / Range

### Calculations

#### F.11. Speed, Time, Distance

Speed, time and distance are critical elements in navigational calculations. Each has its own importance and use in piloting. In planning the sortie or while underway, the typical navigation problem will involve calculating one of these elements based on the value of the other two elements.



F.11.a. Formulas There are three basic equations for speed (S), time (T) and distance (D). Actually, they are the same equation rewritten to calculate each specific element. In each case, when two elements are known, they are used to find the third, which is unknown. The equations are:

- (01) DISTANCE (D) = Speed (S) X Time (T)
- (02) SPEED (S) = Distance (D) / Time (T)
- (03) TIME (T) = Distance (D) / Speed (S)

When working with time it is important that you remember it comes in two varieties; Hours and Minutes. There will be many times when you need to convert minutes to (tenths of hours) and vice versa. Converting (tenths of hours) to minutes multiply by 60. Converting minutes to (tenths of hours) divide by 60. See [F.11.e.](#) and [F.11.f.](#) for details on conversions.

The following examples show how the Speed, Time, Distance equations work.

F.11.b.  
Relationship  
Triangle

The mathematical relationships and formulas can easily be remembered and applied using the triangle shown in [Figure 3-73](#). Put your finger on the missing value and the triangle gives you the correct formula.

- (01)  $D / S = T$
- (02)  $D / T = S$
- (03)  $S \times T = D$

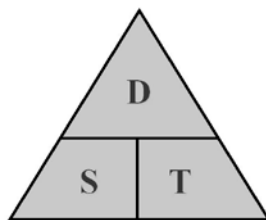

Memory Aid: Daylight Savings Time  
Figure 3-73  
Speed, Time, Distance Triangle

F.11.c.  
Expressing  
Speed, Time, and  
Distance

The formula involving the three elements (speed, time, and distance) must have consistent units of measure. Time is expressed in hours and minutes. Speed is measured in knots. On nautical charts, distance is measured and displayed in nautical miles or yards. Therefore, if speed is measured in knots, and time in hours, then distance will be measured in nautical miles.

- (01) Distance is expressed in nautical miles using the letters NM. On western rivers, distance is expressed in statute miles using M.
- (02) Speed in knots (kts)
- (03) Time in hours and minutes (hrs or min).



---

In calculations and answers, express:

- (04) Distance to the nearest tenth of a nautical mile (11.6 NM)
  - (05) Speed to the nearest tenth of a knot (22.5 kts)
  - (06) Time to the nearest minute (26 min).
- 

F.11.d.  
Converting  
Nautical Miles to  
Yards

An actual NM is 6076.1 feet, or 2,025 yards (YDS), which is equal to 1 minute of arc on a nautical chart. For navigation purposes, the current standard for a nautical mile is equal to 2,000 yards. You will use 2,000 yards for navigation purposes, but by doing so be aware you are building in a slight error in distance.

Converting YDS into NM is done by dividing the yards by 2000.

- (01)  $2000 \text{ YDS} / 2000 = 1 \text{ NM}$ ,
  - (02)  $10000 \text{ YDS} / 2000 = 5 \text{ NM}$ ,
  - (03)  $20000 \text{ YDS} / 2000 = 10 \text{ NM}$ .
- 

F.11.e.  
Converting  
Minutes to  
Tenths

Converting Minutes into Tenths of hours is done by dividing the minutes by 60.

- (04)  $15 \text{ MIN} / 60 = .25 \text{ HRS}$
  - (05)  $30 \text{ MIN} / 60 = .5 \text{ HRS}$
  - (06)  $45 \text{ MIN} / 60 = .75 \text{ HRS}$
  - (07)  $60 \text{ MIN} / 60 = 1.0 \text{ HRS}$
- 

F.11.f.  
Converting  
Tenths to  
Minutes

Converting Tenths of Hours into Minutes is done by multiplying by 60.

- (08)  $.25 \text{ HRS} \times 60 = 15 \text{ MIN}$
  - (09)  $.5 \text{ HRS} \times 60 = 30 \text{ MIN}$
  - (10)  $.75 \text{ HRS} \times 60 = 45 \text{ MIN}$
  - (11)  $1.0 \text{ HRS} \times 60 = 60 \text{ MIN}$
-



F.11.g. Example  
#1 – Solve for  
Distance

If a boat is traveling at 10 knots, how far will you travel in 20 minutes?  
Solve for distance (D).

**Find Distance**

Step	Action
1	Write the equation. $D = S \times T$
2	Substitute information for the appropriate letter $D = 10 \text{ kts} \times 20\text{min}$ (convert to $20\text{min}/60 = .33$ tenths of hour)
3	$D = 10 \times .33 \text{ hrs}$
4	$D = \underline{3.3 \text{ NM}}$

F.11.h. Example  
# 2 – Solve for  
Distance

At a speed of 10 knots, it took the boat 1 hours and 15 minutes to go from the station to the shipping channel. What is the distance to the shipping channel?

**Find Distance**

Step	Action
1	Write the equation. $D = S \times T$
2	Substitute information for the appropriate letter $D = 10 \text{ kts} \times T$
3	$D = 10 \text{ kts} \times 1\text{hrs } 15\text{min}$ ( $15\text{min} / 60 = .25$ tenths of hour) $D = 10 \text{ kts} \times 1.25\text{hrs}$
4	$D = \underline{12.5 \text{ NM}}$





F.11.i. Example  
#3 – Solve for  
Speed

A boat has traveled 12 NM in 30 minutes. What is its speed (S)?

**Find Speed**

Step	Action
1	Write the equation. $S = D / T$
2	Substitute information for the appropriate letter $S = 12 \text{ NM} / T$
3	$S = 12 \text{ NM} / 30\text{min}$ (30min / 60 = .5 tenths of hour) $S = 12 \text{ NM} / .5\text{hrs}$
4	$S = 24 \text{ kts}$

F.11.j. Example  
#4 – Solve for  
Speed

A vessel's departure time is at 2030 local time; the distance to the destination is 30 NM away. Calculate the speed the boat must maintain to arrive at 2400 local time.

Step	Action
1	Calculate the time interval between 2030 and 2400. To determine the time interval, convert time to hours and minutes and then subtract. 23 hours 60 minutes (2400) <u>-20 hours 30 minutes (2030)</u> = 3 hours 30 minutes
2	Write the equation. $S = D / T$
3	Substitute information for the appropriate letter $S = 30\text{NM}/T$
4	$S = 30\text{NM}/3\text{hrs } 30\text{min}$ (30min / 60 =.5 tenths of hour) $S = 30\text{NM}/3.5\text{hrs}$
5	$S = 8.57 \text{ kts}$ , so round up the number to 8.6 knots



F.11.k. Example  
#5 – Solve for  
Time

The boat is cruising at 15 knots and has 12 NM more to go before reaching its destination. Determine how many minutes are needed to arrive at the destination.

Step	Action
1	Write the equation. $T = D / S$
2	Substitute information for the appropriate letter $T = 12\text{NM} / S$
3	$T = 12\text{NM} / 15\text{kts}$
4	$T = .8\text{hrs} (.8 \times 60 = 48\text{min})$ $T = 48 \text{ minutes}$



## Rules

**F.12. Three & Six Minute Rules** The safe navigation of some waterways (i.e. restrictive waters) requires the prudent mariner to fix the vessel's position much more often than what would be required in open waters. Even though transit speeds in these waters are greatly reduced, it is still possible to rapidly move into danger if fix intervals are too far apart.

The three and six minute rules are tools frequently used during piloting navigation to quickly determine distance or speed.

Depending on which rule is used, both are based on two known values, time in minutes (3 or 6) and distance in yards or nautical miles.

F.12.a. Three Minute Rule

Yards traveled, in 3 minutes, Divided by 100, equals Speed and conversely,

Speed, in 3 minutes, Multiplied by 100, equals Yards traveled.

F.12.a.1.  
Example – Three Minute Rule

A vessel traveling at a speed of one (1) knot would cover one (1) nautical mile in one (1) hour. So, to start with, let's change the time to just one minute and see how far the vessel will go (still at 1 knot).

Since one nautical mile in navigation equals 2000 yards, and one hour is 60 minutes, we can surmise that the vessel would travel 33.333 yards for every minute (at 1 knot). (e.g.  $2000 \div 60 = 33.333$  yards per minute).

Knowing that the vessel will travel 33.333 yards per minute is not much help until we note that three (3 *min.*) times that number equals 99.999 yards which is extremely close to the number 100, and that number is quickly and easily calculated in math formulas. Therefore, for every knot of speed, in 3 minutes, you will travel 100 yards. (See examples below).

**NOTE** 

The 3-Minute Rule is based on Distance in Yards, and the number 100.

F.12.a.2. Find Speed

To find Speed using the 3 Minute Rule:

Distance (yards) divided by 100 = Speed

$$800 \text{ yds} \div 100 = 8.0 \text{ kts}$$

$$1000 \text{ yds} \div 100 = 10 \text{ kts}$$

$$1050 \text{ yds} \div 100 = 10.5 \text{ kts}$$

**NOTE** 

When dividing yards by 100 to find speed, simply move left two places from the end and place a decimal.

$$1000 = 10.0 \text{ knots}$$



F.12.a.3. Find  
Distance

To find Distance using the 3 Minute Rule:

Speed multiplied by 100 = Distance (yards)

8 kts x 100 = 800 yards

10 kts x 100 = 1000 yards

10.5 kts x 100 = 1050 yards

**NOTE** ☞

When multiplying yards by 100, simply move the decimal position two places to the right and you will have the speed.

10. = 1000 yards

F.12.b. Six  
Minute Rule

Nautical Miles traveled, in 6 minutes, multiplied by 10, equals Speed

and, conversely,

Speed, in 6 minutes, divided by 10 equals Nautical Miles traveled.

F.12.b.1.  
Example – Six  
Minute Rule

Six is one tenth of an hour, and each tenth equals 6 minutes.

Consider that your vessel would travel 12 nautical miles in one hour. For each tenth (*6 minutes*) of an hour you would travel 1.2 NM. Simply stated if you applied 1.2 NM to each tenth of that hour (x10), then they would equal 12 NM.

Therefore, in six minutes, the distance multiplied by 10 equals speed; and conversely, in six minutes, the speed divided by 10 equals distance traveled in nautical miles. (See examples below)

**NOTE** ☞

The 6-Minute Rule is based on Distance in Nautical Miles, and the number 10.

F.12.b.2. Find  
Speed

To find Speed using the 6 Minute Rule:

Distance (NM) multiplied by 10 = Speed

.8 NM x 10 = 8.0 kts

1.0 NM x 10 = 10 kts

1.5 NM x 10 = 15 kts

**NOTE** ☞

Simply move the decimal one place to the right, when multiplying nautical miles by 10.

1.0 = 10.0 knots.

F.12.b.3. Finding  
Distance

To find Distance using the 6 Minute Rule:

Speed divided by 10 = Distance (NM)

8 kts ÷ 10 = .8 NM

10 kts ÷ 10 = 1.0 NM

15 kts ÷ 10 = 1.5 kts



**NOTE** 

Simply move the decimal one place to the left, when dividing nautical miles by 10.  
10. = 1.0 nm

**F.13. Nautical Slide Rule**

The nautical slide rule was designed to solve speed, time and distance problems. Use of the slide rule provides greater speed and less chance of error than multiplication and division. Just like the formulas discussed earlier in this section, if two pieces of information are known, the third can be calculated.

The nautical slide rule has three scales that can rotate. The scales are clearly labelled for:

- (01) Speed.
- (02) Time.
- (03) Distance.

The outside wheel is used to read distance and is marked in both yards and nautical miles. The larger inside window is used to read time, and is marked in both hours and tenths of hours, and minutes. The smaller, inside window is used to read speed in knots (**Figure 3-74**). By setting any two of the values on their opposite scales, the third is read from the appropriate index. By setting any two of the values on their opposite scales, the third is read from the appropriate index. **Figure 3-74** is set for the approximate values of speed of 18.2 knots, time of 62 minutes and distance of 18.4 NM or 36,800 yards.

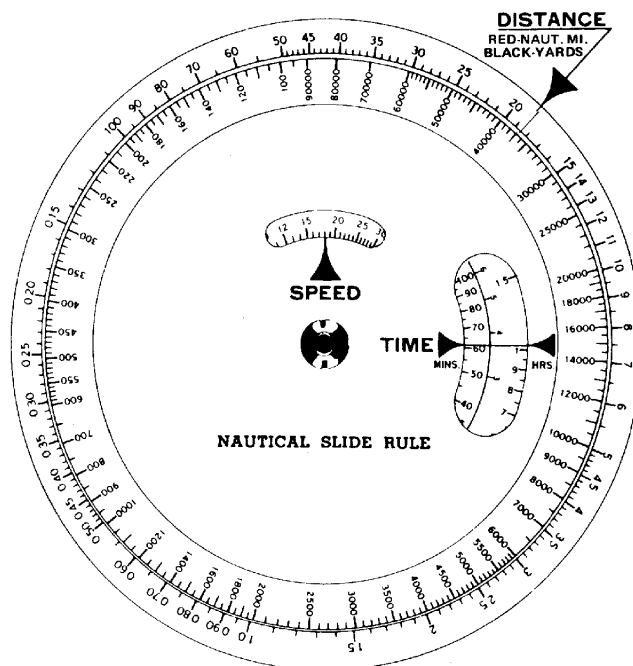

**Figure 3-74**  
Nautical Slide Rule



## Critical Considerations

### F.14. Fuel Consumption

In calculating solutions for navigation problems it is also important to know how much fuel the boat will consume. This is to ensure that there will be enough fuel onboard to complete the sortie. There must be enough fuel to arrive on scene, conduct operations, and return to base (or a refuelling site).

#### F.14.a. Calculating Fuel Consumption

Calculating fuel consumption may be done by performing the following procedures:

Step	Procedure
1	Ensure fuel tank(s) are topped off.
2	Measure and record total gallons in fuel tank(s).
3	Start engine(s).
4	Record time engine(s) were started.
5	Set desired RPMs for engine(s).
6	Record set RPMs.
7	Maintain set RPMs.
8	Stop engine(s) at a specified time (usually one hour).
9	Record time.
10	Measure and record total gallons of fuel in tank(s).
11	Subtract total gallons in tank(s) after running one (1) hour from total gallons recorded on boat at beginning of underway period.
12	Record the difference.
13	Measure the distance travelled and record.
14	Compute boat speed and record.
15	Apply the equation: Time (T) multiplied by gallons per hour (GPH) equals total fuel consumption (TFC); or $T \times GPH = TFC$ .
16	Calculate TFC for other selected RPM settings. (Change RPM setting and repeat steps 6 through 15.)



**F.15. Speed Curve (Speed vs. RPMs)**

A speed curve is used to translate tachometer readings of revolutions per minute (RPMs) into the boat’s speed through the water. A speed curve is obtained by running a known distance at constant RPM in one direction and then in the opposite direction. The time for each run is recorded and averaged to take account for current and wind forces. Using distance and time, the speed is determined for the particular RPM. **Table 3-5** is an example of a boat speed vs. RPM curve.

Speed, Kts Calm Water	Approx. RPM	Fuel Gal/Hour	Consumption Gal/Mile	Cruise Radius/Miles
7.60	760	3.86	.51	882
7.89	1000	4.99	.63	712
9.17	1250	7.50	.82	550
9.48	1500	12.75	1.31	335
12.50	1750	16.80	1.35	333
15.53	2000	21.00	1.35	333
19.15	2250	33.00	1.72	261
21.34	2400	33.75	1.58	284

**Table 3-5**  
**Speed vs. RPMs Conversion (Example)**

**F.16. Alarms**

Integrated navigation systems have numerous alarms available, but they provide valuable information only if they are properly configured for the prevailing navigational situation. Too few alarms increase the risk to the safe navigation of the vessel. However, setting too many alarms creates distractions and makes it difficult or impossible to identify risk to the safe navigation of the vessel. Agency leaders and coxswains must consider alarm management during the planning process to determine the setup and preferred response to alarms and those conditions when an alarm may be silenced or disabled.

**F.17. Verification**

Planning for a voyage and preparation of equipment, including data entry and setup of integrated navigation systems, presents numerous opportunities for errors. During navigation planning, ensure that systems are aligned and contain the same basic route information. Verifying navigation preparations is a checkpoint in the navigation planning process; errors can also be detected while actively navigating by performing system cross-checks throughout the voyage.



## **F.18. Briefs**

Briefs are a critical element of the navigational planning process and ensure safe navigation. They are tailored specifically to operations and serve to ensure all members involved have a common understanding of the risks present and actions to mitigate those risks. Topics addressed in a nav brief should include:

- (01) Assignment of crew positions,
  - (02) Review of charts and intended track / patrol area,
  - (03) Safe speed for mission & conditions,
  - (04) Identification of hazards to navigation and how risk will be controlled,
  - (05) Anticipated traffic and AIS correlation,
  - (06) Environmental considerations including tides, currents, weather (e.g., winds, precipitation, visibility), and environmentally sensitive sea areas (e.g., marine sanctuaries),
  - (07) Maximum allowable deviation from track and confirmation that electronic chart cross track warnings are aligned with max deviation from track.
-





---

## Section G. Piloting

---

**Introduction** Piloting is executing of a navigation plan and encompassing the use of seaman's eye, electronic, and paper chart navigation methods. Combining and transitioning between these methods may become necessary at any given time making your knowledge and employment of these practices critical to safe navigation. Regardless the method used, it is important to remain alert and attentive at all times, and always be consciously aware of where the boat is and where it will soon be.

**In this Section** This section contains the following information:

Title	See Page
<a href="#">Approaches to Piloting</a>	3-129
<a href="#">Piloting Tools</a>	3-132
<a href="#">Dead Reckoning</a>	3-138

---

### Approaches to Piloting

**G.1. Overview** For the safety of the boat, it is desirable to follow the navigation plan, notably those tracklines placed on the electronic or paper chart, and to avoid any hazards to navigation or other vessel traffic that may be identified during a sortie.

In some situations, such as an open ocean transit, it is not necessary to adjust course or speed every time a fix is obtained that shows you to be only close to the intended position along a track. It may be that you are using an electronic method of navigation with an acceptable margin of error, or ocean currents, and wind conditions are having a relatively small effect on your attempt to follow a certain track.

In other situations, such as approaching a port or harbor or transiting a narrow channel, you may have to constantly adjust course and/or speed to ensure the safe passage of the boat.

---



## G.2. Over Reliance

Over reliance on any one system can lead to a mishap. Crews must understand all of the navigation systems, equipment and techniques available and how they can be used to accomplish safe navigation in the event a preferred method fails. Good boat operators have the skills necessary to detect a failure or bad information and the skills to take action or react so the mission can be completed or the consequences minimized.

How would you react to losing your chart plotter or GPS? Would you quickly be able to know where you are? How fast could you get visual fixes to AtoN or landmarks to confirm where you are? Would you know to reference a paper chart to check expected depth and then correlate with the depth sounder?

Too often, coxswain and crews are relying on one system to get them from point A to point B. Steps that can be taken to avoid over reliance on any one methods include:

- (01) Conducting frequent what if scenarios.
- (02) Purposely limiting systems use and switching to other approved means to improve skill set.
- (03) Maintaining familiarity with alternate navigation methods (electronic, paper plot).

### NOTE

Using the depth sounder to confirm the position with charted depth of water is often difficult in heavy weather where aerated water can throw off the reading.



**G.3. Technological & Classic Piloting Methods**

**Table 3-6** illustrates the impact integrated navigation systems and GPS technology has made on classic or traditional navigation methods. Though these technologies have become the preferred means of navigating a boat, it remains necessary for crews to understand and be capable of employing classic methods in order to overcome equipment failures and adapt to the situation.

Technological Environment	Classic	Difference
Electronic Piloting – Multi-Function Display, Chart Plotter	Piloting techniques- Seaman’s Eye, Visual (e.g. terrestrial / fixed AtoN alignment)	Traditional piloting versus piloting with additional sources of information to confirm position
Electronic Chart Plotter / Radar Graphic User Interface (GUI)	Radar (e.g. parallel indexing)	Moves from reliance on piloting with radar alone to aligning the “boat’s position” on the electronic chart in real time with radar overlay
GPS/DGPS	LOP fix	Fix moved from reliance on visual or radar LOPs to using coordinates provided by satellites with greater than 99% reliability

**Table 3-6  
Technological & Classic Navigation Environments**



#### G.4. Seaman's Eye

Seaman's Eye is to estimate your position without navigational instruments by utilizing distances and angles obtained from instinctive knowledge and experience of the local maritime environment. It is the least reliant on technology, requiring instead an extensive knowledge of the local area to include aids to navigation, terrestrial landmarks, and depth contours. This knowledge, coupled with a chart of the area, is an acceptable method for navigation. In many cases, the coxswain maintains an awareness of the boat's position utilizing Seaman's Eye while verifying the position with information such as depth of water or visual bearing of a landmark.

For example, when navigating a marked channel the crew can position the boat between the navigational aids, maintaining the lateral markers off the appropriate side of the boat, and verify position when passing a marker by comparing the charted depth of water to that displayed on the depth sounder.

### Piloting Tools

#### G.5. Paper Chart Preparations

Crews employing paper charts as a primary or backup means of navigation should take the following steps regardless the intended method of obtaining fixes during the transit.

Step	Procedure
1	Ensure charts covering operational area are up-to-date and correct with shoal water and hazards highlighted.
2	Plot waypoints and label with name or number.
3	Plot and label tracklines.
4	Label chart shifts as needed (Indicated by two // and the chart number on the trackline at a point immediately before the shift is necessary).



**G.6. Electronic Charting System** Crews employing an electronic charting system to follow a navigation plan should take the following steps:

Step	Procedure
1	Ensure planned waypoints and tracklines are entered into the electronic chart plotter.
2	Verify system navigation calculations against chart work or backup system (i.e. GPS).
3	Assign helmsman and lookout.
4	Verify displayed position using radar, depth sounder, terrestrial ranges, and AtoN.
5	Activate route.
6	Verify Cross Track Error Alarm is set.
7	Verify depth alarms are set in accordance with unit navigation standards.
8	Provide initial and revised ETA as conditions change. Begin transit at planned speed.
9	Direct helmsman toward next waypoint using system navigation data, visual and radar information to make good estimated times along the planned track.
10	Conduct frequent reports of the navigation situation to crew (i.e. distance left/right of track, time to go to turn, nearest hazard to navigation, depth below keel, recommended course). Verify displayed position using radar, depth sounder, terrestrial ranges, and AtoN.
11	Make turns on-time to maintain trackline.
12	Adjust navigation plan and update remaining ETAs as needed due to traffic, safe speed, sea conditions, etc.



G.6.a. Cross Track Error

Cross Track Error (XTE) is an automatic navigation alarm function found in many electronic charting systems and GPS receivers that alerts users upon deviation from the intended trackline. When the vessel's position has exceeded the maximum allowable XTE, the system triggers an alarm. This alarm serves to prompt the operator to immediately address the situation. In **Figure 3-75** the vessel has exceeded the maximum allowable XTE value. Desired reaction-gap determines the value of the XTE alarm, with the intent being to provide vessel operators enough time to correct errors prior to mishap.

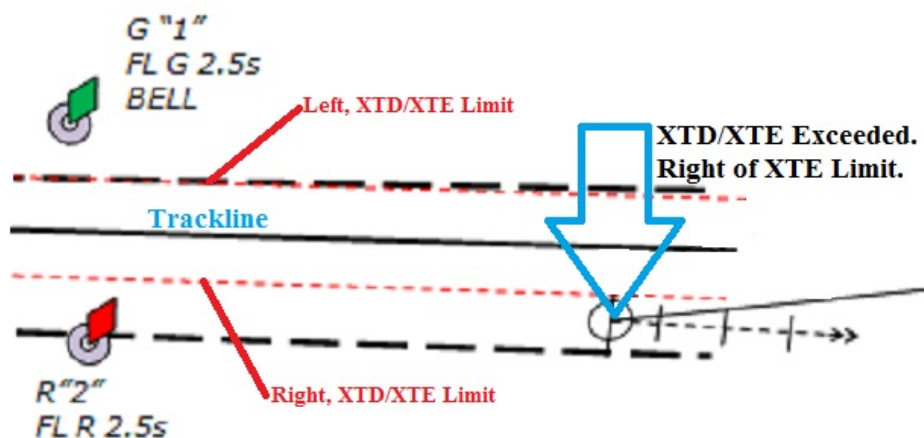

Figure 3-75  
Cross Track Error (XTE)



**G.7. GPS/DGPS** Crews employing a GPS/DGPS receiver to follow a navigation plan should take the following steps:

Step	Procedure
1	Enter and name/number planned waypoints into the GPS/DGPS.
2	Insert waypoints into a route using the GPS route menu.
2	Verify system navigation calculations against chart work.
3	Assign helmsman and lookout.
4	Activate route.
5	Verify Cross Track Error Alarm is set.
6	Verify depth alarms are set in accordance with unit navigation standards.
7	Provide initial and revised ETA as conditions change. Begin transit at planned speed.
8	Direct helmsman toward next waypoint using GPS navigation data, visual and radar information to make good estimated times along the planned track.
9	Plot fixes at prescribed fix interval. Verify displayed position using radar, depth sounder, terrestrial ranges, and AtoN. Come to bare steerageway/ stop if unable to fix position, maintain plot, or piloting situation unclear.
10	Plot and label DR course.
11	Recommend course to maintain or regain track. Factor variation and deviation into courses when providing compass course guidance to helmsman.
12	Conduct frequent reports of the navigation situation to crew (i.e. distance left/right of track, time to go to turn, nearest hazard to navigation, depth below keel, recommended course).
13	Make turns on-time to maintain trackline.
14	Adjust navigation plan and update remaining ETAs as needed due to traffic, safe speed, sea conditions, etc.



### G.7.a. Highway Display

Allows users to view the course, as indicated by current waypoint, and the distance to the left or right of the track as well as course and speed over ground (COG/SOG). This display is similar in nature to a GPS display in your car where it shows your track as if it were on a highway, hence the name highway display. As previously mentioned, the XTE can be set for a variety of distances but always remember the reaction gap.

#### Highway display

The highway display provides a 3-D view of own ship's progress toward destination (waypoint). Nav data is also shown.

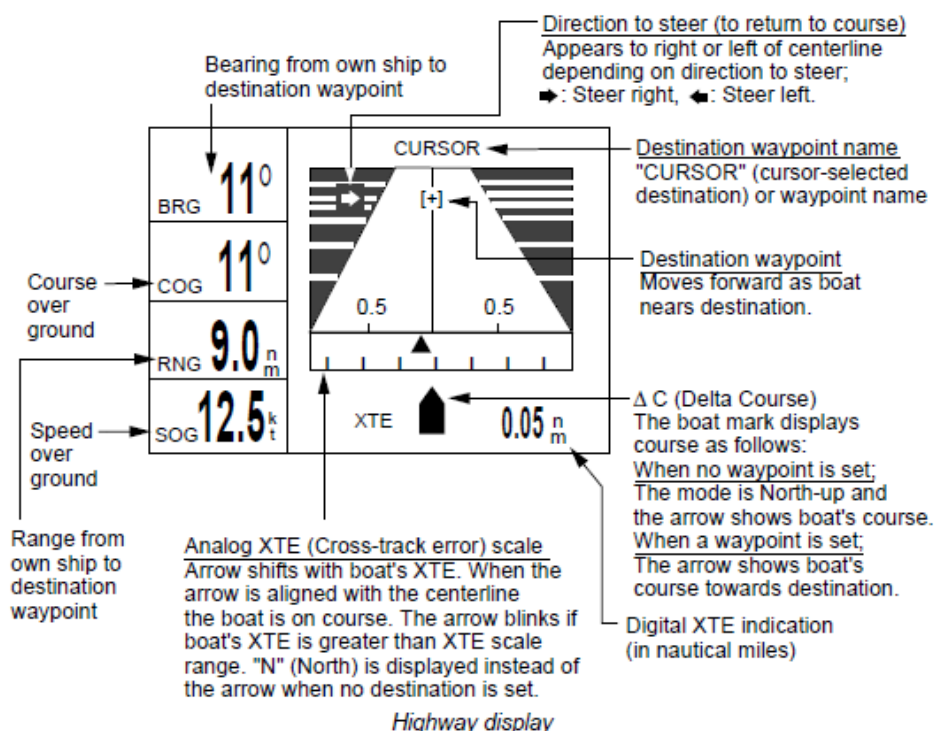

Figure 3-76  
GPS Highway Display





## G.8. Radar

Crews employing radar to follow a navigation plan should take the following steps:

Step	Procedure
1	Plot and label planned tracks on a paper chart. Include turn ranges if available.
2	Activate and properly tune radar set.
3	Verify depth alarms are set.
4	Assign helmsman and lookout.
5	Provide initial and revised ETA as conditions change. Begin transit at planned speed.
6	Direct helmsman toward next waypoint using visual and radar information to make good estimated times along the planned track.
7	Plot fixes at prescribed fix interval. Verify position using depth sounder, terrestrial ranges, and AtoN. Come to bare steerageway/ stop if unable to fix position, maintain plot, or piloting situation is unclear.
8	Plot and label DR course.
9	Recommend course to maintain or regain track. Factor variation and deviation into courses when providing compass course guidance to helmsman.
10	Conduct frequent reports of the navigation situation to crew (i.e. distance left/right of track, time to go to turn, nearest hazard to navigation, depth below keel, recommended course).
11	Report radar scan 'next leg clear' (or conning action based on next leg not clear) before turning.
12	Make turns on-time to maintain trackline.
13	Adjust navigation plan and update remaining ETAs as needed due to traffic, safe speed, sea conditions, etc.



## Dead Reckoning

### G.9. Dead Reckoning

Dead reckoning (DR) is one of the most widely used methods of navigation. The term dead reckoning is derived from deduced reckoning, a process by which a vessel's position is deduced or computed mathematically in relation to a known point.

Even though we now use charts that allow us to determine these same solutions graphically, the old traditional term continues to be used.

Dead reckoning is used any time a vessel is underway. The primary reason for using dead reckoning is that the navigator may, at any time, give a reasonable account of the vessel's position without having to take sights or obtain a position by another means.

#### G.9.a. Key Elements of Dead Reckoning

Dead reckoning is the process of estimating your vessel's position by applying, from your last known established fix, a vector based on the course that you are trying to steer and speed of advance out for a specified period of time, normally fix interval. The Coast Guard Navigation Standards Manual requires that each fix be followed by a DR track of at least two fix intervals. The DR process makes use of the following two principles:

- (01) Course steered (direction),
- (02) Distance runs (speed).

#### NOTE

The effects of wind and current are not considered in determining DR position. If the effects of known or anticipated wind and currents are included, the result is a plot of "Estimated Position" (EP).

#### NOTE

Dead reckoning must be used with extreme caution in the vicinity of shoal waters and/or other hazards to navigation.

#### G.9.b. Labeling a DR Position

**Figure 3-77** shows how a DR position is to be labeled on a trackline. The DR position is marked with a semi-circle around a small dot on a straight segment of a course line. The time (to the nearest minute) in 24-hour system is written nearby. The letters DR are not used.

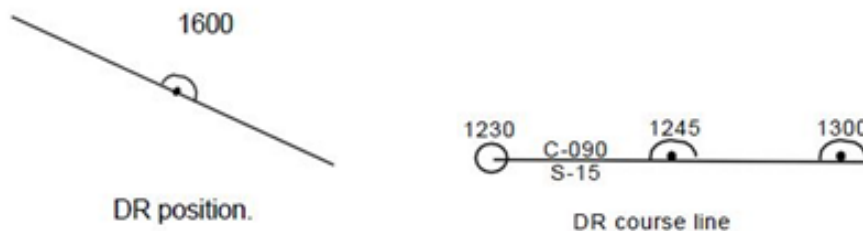

**Figure 3-77**  
Labelling a DR Position & Course



**G.10. Estimated Position**

An estimated position is a DR position modified by additional information which in itself is insufficient to establish a fix. An estimated position is

- (01) The common intersection of two LOPs obtained from simultaneous observations.
- (02) Based on DR position and a single LOP.
- (03) An actual course line between a fix and an estimated position.

Estimated position (EP): A point marked with a small square and the time it was obtained. (**Figure 3-78**).

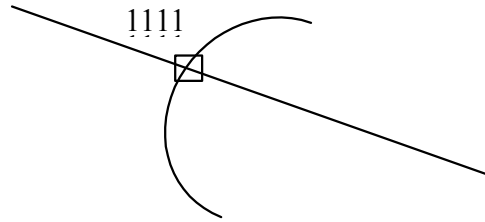

**Figure 3-78**  
**Estimated Position**



### G.11. DR Plot

The DR plot starts with the last known position (usually a fix). The procedures for labelling a DR plot are given below (see [Figure 3-77](#)).

Step	Procedure
1	Plot the course line, label it clearly and neatly. (01) Course: Above the course line, place a capital C followed by the ordered course in three digits. (02) Speed: Below the course line, place a capital S followed by the speed.
2	Use standard symbols to label a DR plot: (01) Circle or triangle for a fix. (02) Semicircle for a DR position. (03) Square for an estimated position.
3	Plot a DR position: (01) At least every half hour. (02) At the time of every course change. (03) At the time of every speed change.
4	Start a new DR plot from each fix or running fix (plot a new course line from the fix).
5	Time is written as four digits.

The course can be magnetic (M), true (T) or compass (C) and is always expressed in three digits. If the course is less than 100°, zeros are prefixed to the number, for example, 009°.



G.11.a. Sample DR Plot

A DR plot typically includes many types of LOPs and fixes. **Figure 3-79** is provided as an example of what could appear on a properly maintained DR plot. Some of the fixes within the figure have not been discussed within the text.

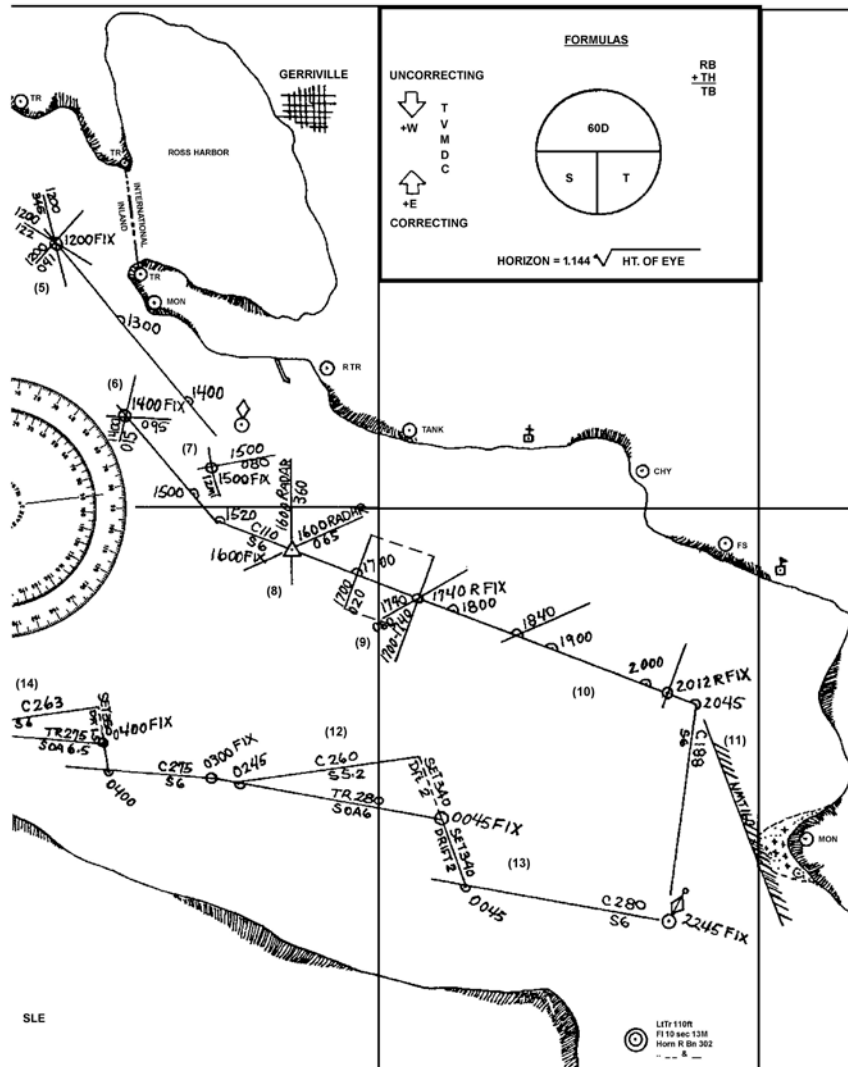
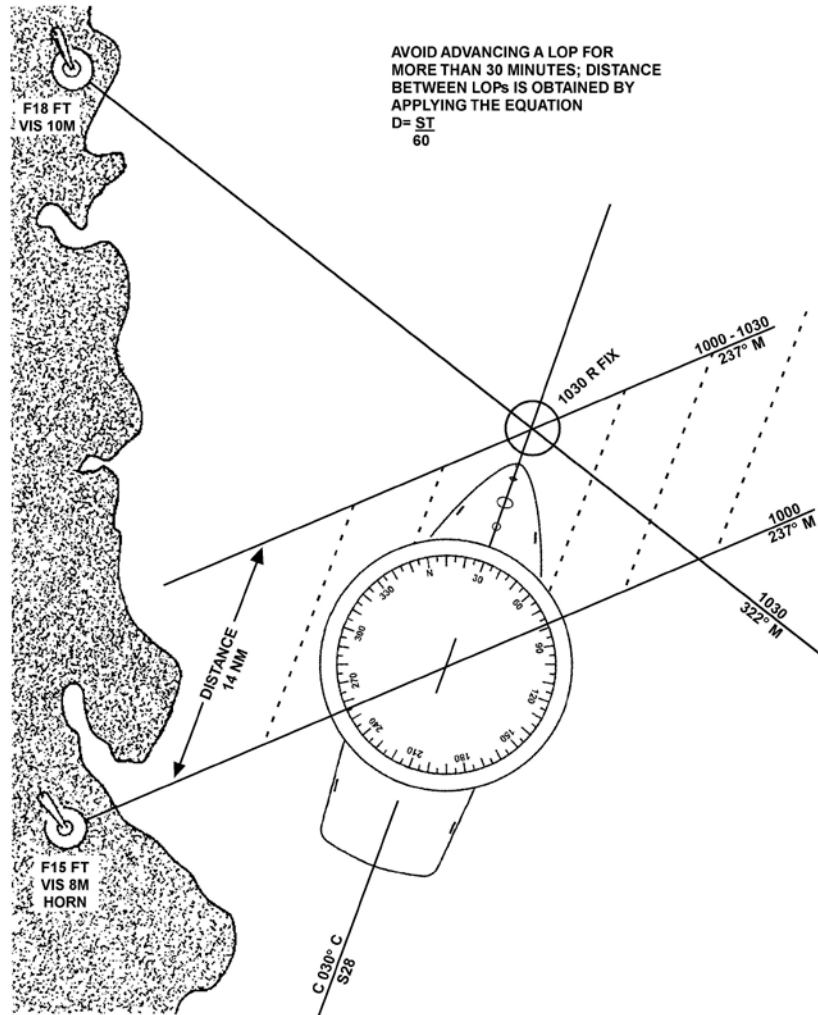

Figure 3-79  
Sample DR Plot

G.12. Running Fix

Often it is impossible to obtain two bearing observations within a close enough interval of time to be considered simultaneous. A running fix (R Fix) can be obtained by using two LOPs acquired at different times. It is determined by advancing an earlier LOP by using dead reckoning calculations of the boats direction and distance travelled during an interval (**Figure 3-80**).



**Figure 3-80**  
**Running Fix**

Plot a running fix by performing the following procedures:

Step	Procedure
1	Plot the first LOP. Plot the second LOP.
2	Advance the first LOP along the DR plot to the time of second LOP. (The first LOP is advanced by moving it parallel to itself, forward along the course line for the distance the boat will have travelled to the time of the second bearing.)
3	Where the two LOPs intersect is the running fix.
4	Avoid advancing an LOP for more than 30 minutes.



G.12.a. Sample Running Fix

At 1000, a compass bearing of 240° to a light is observed, which is corrected to 237° M. There were no other well-defined objects from which to obtain a bearing. Since plotting the first LOP the boat has run at 28 knots on a compass course of 030° C.

At 1030, the boat has a second compass bearing of 325° to the light is observed. Plot this as a second LOP and advance the first LOP. The position where they cross is the running fix (**Figure 3-80**).

Step	Procedure
1	Obtain the time interval and the distance the boat travelled since the 1000 LOP. (A nautical slide rule may be used) 10 hours 30 minutes <u>-10 hours 00 minutes</u> 30m - time interval Apply the equation for distance (nautical slide rule may be used). $D = S \times T/60$ $D = 28 \times 30/60$ $D = 840/60$ $D = 14$ nautical miles
2	Using dividers, measure the distance (14 NM) off of the latitude or nautical mile scale along the course line in the direction travelled.
3	Advance the first LOP, ensuring it is moved parallel to itself, forward along the course line for the distance travelled (14 NM). Draw the LOP labelling the new line (1000-1030) to indicate that it is an advanced LOP.
4	Correct the compass bearing of the second light (325° C) to obtain the magnetic bearing (322° M)
5	Plot the bearing. A running fix has been established by advancing an LOP.



---

**G.13. Set & Drift** The difference between the dead reckoning (DR) position and an accurate fix is the result of the action of various forces on the ship, such as the effects of ocean or tidal currents, wind, helmsman error, etc. Regardless of which or how many of these factors make-up the difference between the DR position and the fix, this difference is referred to as the effect of the current, even though only a small part of it may actually be the result of tidal currents. The differences are expressed as set and drift.

- (01) Set is the direction of a line drawn from the DR position to the fix. This vector is the direction that you are being set towards.
- (02) Drift is the speed indicated by the length of the vector from the DR position to the fix.

---

G.13.a. Set To determine set, you simply measure the direction **from** the DR position to the fix (this can be done with parallel rules and a compass rose or a parallel motion protractor); set is expressed in degrees, usually true degrees.

---

G.13.b. Drift Determining drift is a simple time, speed, and distance problem. Measure the length of the vector (distance), determine the time between fixes (time), and solve for the unknown (speed). The results are expressed in knots and tenths of knots.

---

G.13.c. Tidal Current Charts *Tidal Current Charts* are available for certain bodies of water such as Boston Harbor or San Francisco Bay. They graphically indicate the direction and velocity of tidal currents for specific times with respect to the state of the current predictions for major reference Stations. These charts make it possible to visualize how currents act in passages and channels throughout the 12-hour cycle. By referring to the current charts, it is possible to plan a passage that is made quicker by either taking advantage of a favorable current or picking a track that reduces the effect of a head current.

---

G.13.d. Tidal Current Tables *Tidal Current Tables* are used to predict tidal currents. Examples of how to apply predicted currents are found in the back of the publication. This makes it possible to apply the corrections well in advance so as to avoid the dangers along the way and safely arrive at the destination. This method involves the use of a vector diagram called a current triangle.

---





G.13.e. Current Triangle

The current triangle is a vector diagram indicating the course and speed the boat will make good when running a given course at a given speed (**Figure 3-81**). It can also be used to determine the course to steer and the speed necessary to remain on the intended track. This information may be obtained by using the chart's compass rose for constructing a current triangle to provide a graphic solution.

- (01) The first line (AB) on a current triangle indicates the boat's intended direction and the distance to travel in a given period of time. The length of this line represents the boat's speed in knots.
- (02) The second line, (CB) laid down to the destination end of the intended direction (the first line), shows the set (direction) of the current. The length of this line represents the drift (speed) of the current in knots.
- (03) The third line (AC) provides the resulting corrected course to steer and the speed of advance to arrive safely at the destination. If any two sides of the triangle are known, the third side can be obtained by measurement.

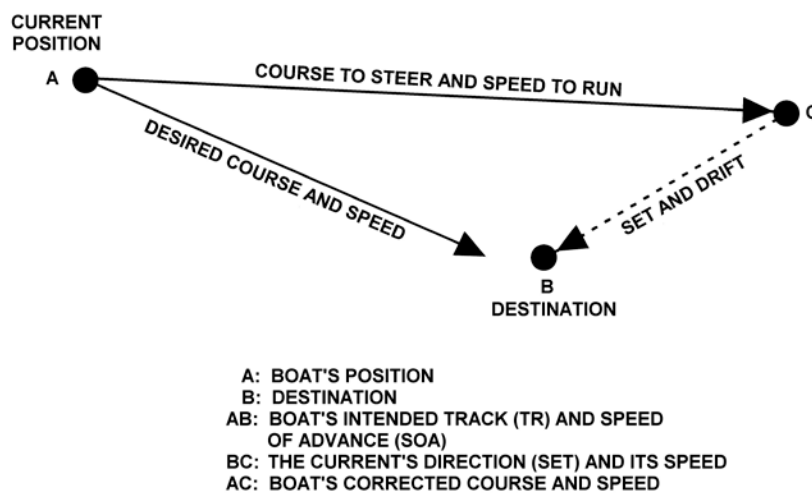

Figure 3-81  
Current Triangle

G.13.f. Plotting Set and Drift to Determine Course to Steer

The intended track to the destination is  $093^\circ$  magnetic (093M), the speed is 5 knots, the *Tidal Current Table* for the operating area indicates that the current will be setting the boat  $265^\circ$  true (265T), drift (speed) 3 knots. The local variation is  $4^\circ$  (W). Obtain the corrected course to steer and SOA to allow for set and drift (**Figure 3-82**). The nautical miles scale, is provided as an example for measuring “units” of length.)

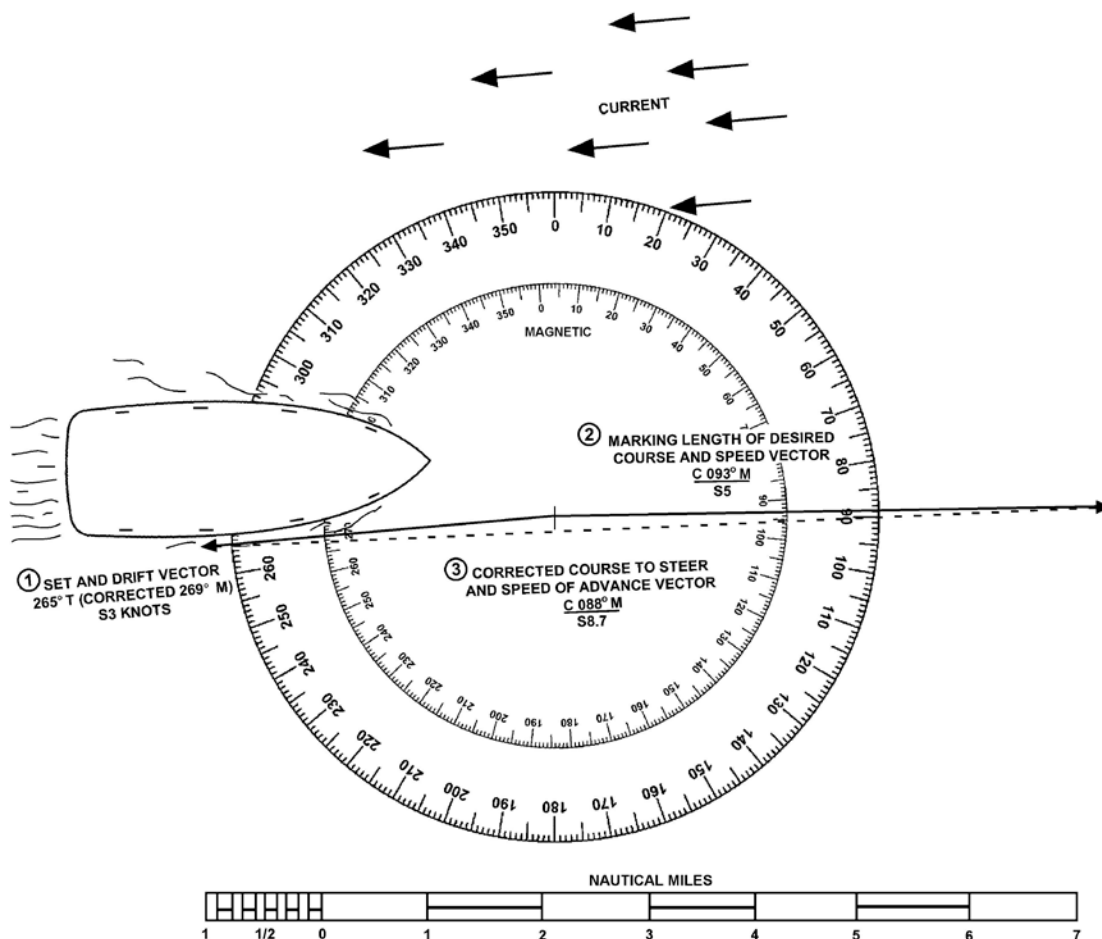

Figure 3-82  
Plotting Set and Drift to Determine Course to Steer

Step	Procedure
1	Lay out the chart. Think of the center of the compass rose as the departure point. Draw the boat's intended track ( $093^{\circ}$ M) from the center of the compass rose. Make this line 5 units in length to represent 5 nautical miles from the center of the compass rose. Put a small arrowhead at this point. This is the desired course and speed vector.
2	Draw a line for the set and drift of the current from the center of the compass rose towards $261^{\circ}$ magnetic ( $265^{\circ}$ T + $4^{\circ}$ W (variation) = $269^{\circ}$ M).



3	Set in the <i>Tidal Current Tables</i> is given in degrees true and must be converted to degrees magnetic to be used. Make this line three units long putting an arrowhead at the outer end. This is the set and drift vector.
4	Draw a straight line to connect the arrowheads of the desired course and speed vector and the set and drift vector. This line is the corrected course to steer and speed of advance.
5	Measure the length of this line to obtain the speed (8.7 knots) from the nautical miles scale.
6	Advance the line to the center of the compass rose and read the corrected magnetic course to steer (088° M) from the inner circle of the compass rose.

Using the same figures as shown in the above example, **Figure 3-83** shows what the effect would be if the set and drift is not corrected for by using a current triangle.

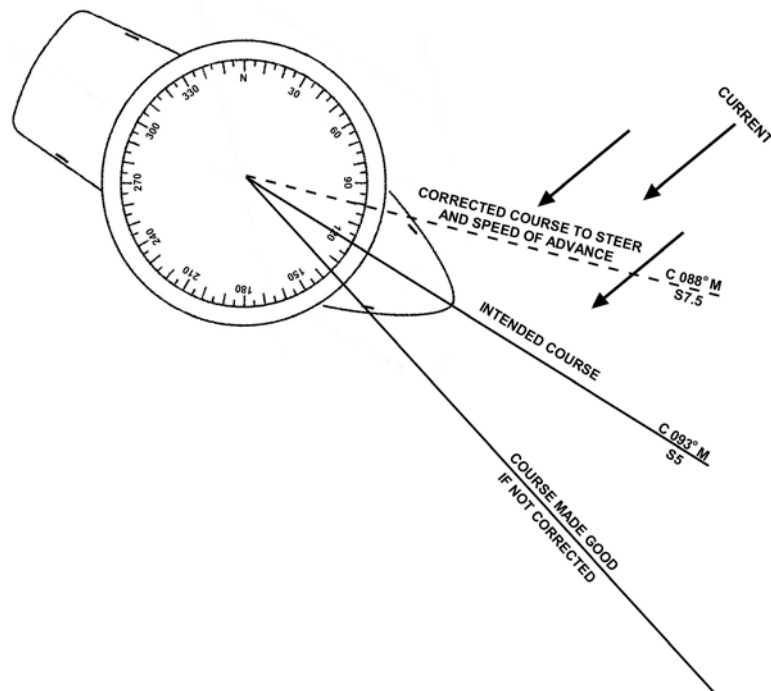

**Figure 3-83**  
 Compensating for Set and Drift



---

## Section H. River Sailing

---

**Introduction** The section provides general information for operating on rivers, with emphasis on the western rivers. The western rivers (Mississippi River system) pose navigational concerns that often are not seen in harbor, coastal, or high seas sailing. Local knowledge is very important. Navigational techniques and the language both have differences that must be learned to become a competent river sailor.

**In this Section**

This section contains the following information:

Title	See Page
<a href="#">Special Considerations</a>	3-148
<a href="#">Conditions and Effects</a>	3-150
<a href="#">Locks and Dams</a>	3-151

**H.1. Special Considerations**

Some of the special considerations for river navigation include:

- (01) Charts,
  - (02) Mile marks,
  - (03) Fixed aids,
  - (04) Buoyage,
  - (05) Compass,
  - (06) DR plot.
-



H.1.a. River Charts

Charts are simple, line drawn “maps” that show the main geographical features of the waterway, the channel or sailing line, prominent man-made objects, and the various aids. River charts do not show landmarks such as stacks, water towers, or antennas. These charts do not always show the geographical names for areas along the bank. River charts only show structures immediately on the banks by symbol and footnote. **Figure 3-84** provides a good example.

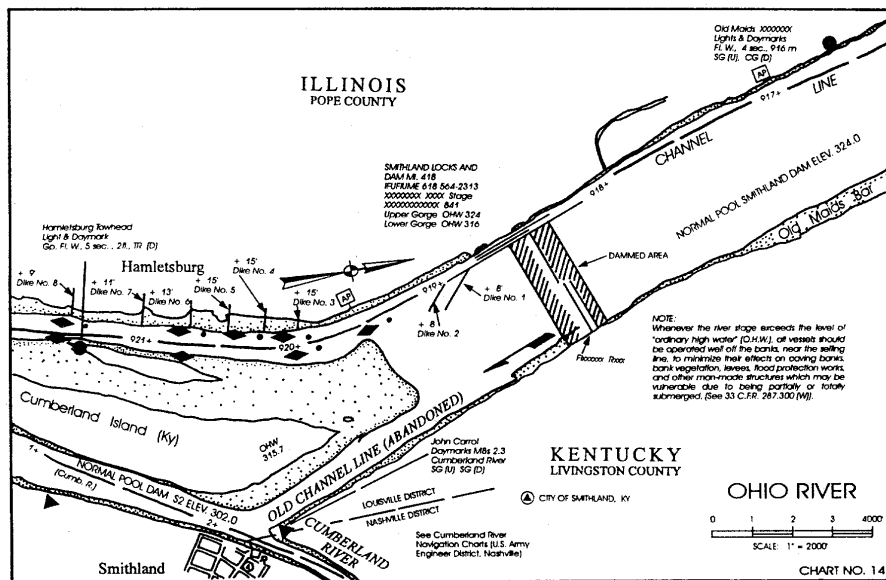

Figure 3-84  
Sample River Chart

H.1.b. Mile Marks

The Western Rivers have mile marks (beginning at the mouth or at the headwaters of the stream).

H.1.c. Fixed Aids

Fixed aids (daymarks and lights) display the mile, usually as statute miles, on a “mile” board for that point of the river. Where no aid exists, landmarks such as bridges, creeks, islands, and overhead power lines provide the mile-mark reference.

H.1.d. Buoyage

The U.S. lateral system of buoyage has differences when used on these rivers.



---

H.1.e. Compass      Compasses are not normally very useful on western rivers because there are no plotting references on the chart and that many rivers meander. However, boat-mounted compasses must be installed. There will be situations where the use of a compass can help determine a position. For example, on a meandering river with no prominent landmarks, comparing the compass heading with the north arrow on the chart will help identify the bend or reach where the boat is operating.

---

H.1.f. DR Plot      As in coastal piloting, a boat's approximate position is determined by dead reckoning, applying its speed, time, and course from its last known position. However, because many rivers have numerous bends, it often is not possible to maintain a complete DR plot with precise course changes.

---

**H.2. Conditions and Effects**      Surface and bottom conditions of a river are unpredictable and can change quickly. Some of the unique situations to deal with include:

- (01) Silting and shoaling.
  - (02) Drift.
  - (03) Flood or drought.
- 

H.2.a. Silting and Shoaling      Silt is a mass of soil particle carried in water. It can clog boat cooling water intakes and wear out strut bearings and shafts. Silt settles on the bottom as shoaling, either adding to or creating sand bars or mud banks.

---

H.2.b. Drift      Drift, or driftwood, is floating debris carried by the river flow and washed or lifted from the banks. Running drift can damage a boat.

---

H.2.c. Flood or Drought      Tides affect rivers near the coast, but a flood or a drought will greatly affect the vertical level (depth) of the entire river.

---

H.2.c.1. Flood      A flood is created by runoff or drainage from heavy rains or melting snow. Navigating outside the riverbanks requires caution and local knowledge. During a flood condition, some dangers may include:

- (04) Currents are much stronger,
  - (05) Channels can shift,
  - (06) Obstructions can be hidden under the water,
  - (07) Drift hazards (trees and other debris) increase,
  - (08) AtoN can be broken,
  - (09) Bridge clearances are reduced.
- 

H.2.c.2. Drought      A drought is a long spell of dry weather that can affect the water level. This



---

can result in the closing of channels. Snags and obstructions that once were cleared easily become hazards to navigation. Also, sandbars and mud flats will appear where it was once safe to operate.

---

**NOTE** 

Refer to Reference (a) for information on operating boats in narrow channels.

---

**H.3. Locks and Dams**

Locks and dams provide a navigable channel for river traffic. Navigation dams release water, as necessary, to maintain a navigable channel during the navigation season. Locks release water as a part of their normal operation. Both of these can be a safety problem for boats. Knowledge of locks and dams, including location, use and associated hazards, is essential for safe boat operations.

---



H.3.a.  
Construction and  
Operation

The navigation dams on the Mississippi, Illinois, and Ohio rivers can be of different construction. Two types of dam construction are the Tainter gate and the Roller gate. Also, some dam releases are controlled remotely. This is the kind of local knowledge that the boat crew needs to check before operating in that area.

Most people know that water released from a dam can create a powerful, turbulent current going downstream. However, upstream water current can exist close to the lower or downstream side of a dam. Operating too close to the downstream side of a dam can result in the boat being drawn into the dam.

A strong suction is created by the rush of water underneath the upper side of a roller-gate dam (**Figure 3-85**). A boat drifting into the dam on the upper side may not be in immediate danger on the surface but it is possible for boats to be drawn into the gates. These areas are usually marked by danger buoys upstream of the dam and should be avoided as much as possible. If entering this area is a must, the lockmaster should be contacted before entering. If the boat enters this area, crewmembers should not go into the water.

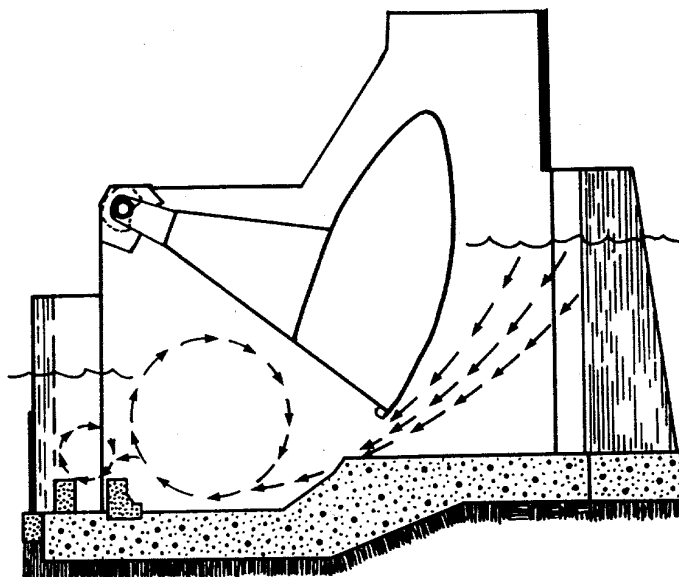

Figure 3-85  
Roller Gate Dam





---

H.3.b.  
Navigation  
Displays

When locks at fixed dams and moveable dams have their dams up, they will show navigation lights during hours of darkness. These lights are green, red, or amber and in groups of one, two or three. A circular disc may also be shown. The significance of these displays is explained in local guidance.

---

H.3.c. Lock  
Operations

The purpose of a lock is to raise or lower the boat to the level of the channel that it wants to continue to navigate. Locks come in all shapes and sizes, but they all operate on the principle that water seeks its own level. A lock is an enclosure with accommodations at both ends (generally called gates) to allow boats to enter and exit. The boat enters, the gates are closed, and by a system of culverts and valves, the water level in the lock aligns with the pool level of the upstream or downstream side of the lock. The gate then opens and the boat can continue on its way.

---



### H.3.d. Locking Procedures

There are many common locking procedures but local regulations can vary. The boat crew must check local guidance for correct locking procedures of each lock. Standard locking signals are shown in **Figure 3-86**. Precautions to take in locking include:

- (01) Do not come closer than 400 feet of the lock wall until the lockman signals to enter.
- (02) Moor to the side of the lock wall as directed.
- (03) If using own mooring lines, they should be at least 50 feet long with a 12-inch eye splice.
- (04) Do not tie mooring lines to the boat; tend the lines as the water level changes.
- (05) Be prepared to cast off lines in an emergency; a small hand axe or hatchet should be available.
- (06) Use fenders.
- (07) Do not moor to ladder rungs embedded in the lock walls.
- (08) Wait for the lockman's signal (an air horn) to depart.
- (09) Depart in the same order of entering the lock with other boats.
- (10) Steer for the channel and keep a sharp lookout for craft approaching from the other direction.

At locks with “small craft signals”, signal the lockman the desire to pass. After signalling, stand clear and wait for instructions. Many locks are radio-equipped. Consult the appropriate navigation charts for radio-equipped locks, their frequency and call sign.

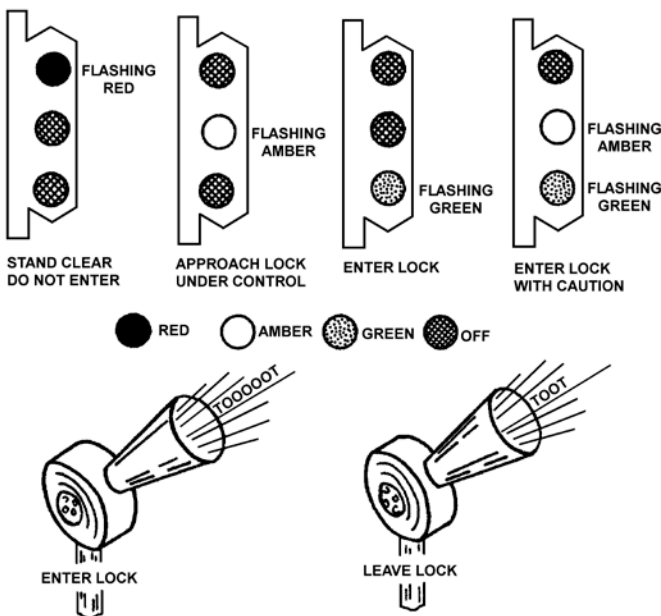

Figure 3-86  
Standard Locking Signals



H.3.e. General Considerations

---

General considerations around locks include:

- (01) The Secretary of the Army sets the priorities for safe and efficient passage of the various types of craft on inland waterways. Priorities, listed in descending order with the highest priority on top, are:
  - a) U.S. military craft.
  - b) Vessels carrying U.S. mail.
  - c) Commercial passenger craft.
  - d) Commercial tows.
  - e) Commercial fisherman.
  - f) Recreational craft.
- (02) Under certain conditions, boats may be locked through with other crafts having a higher priority. This occurs only when there is no delay and neither craft is placed in jeopardy.
- (03) Lockmen have the same authority over a boat in a lock as the traffic police have over a car at an intersection. For safety purposes, obey the lockman's instructions.
- (04) Every boat should carry a copy of, and the crew should be familiar with the regulations governing navigation on the rivers in its AOR.

**H.4. Safety Considerations Around Navigation Dams**

---

General safety considerations include:

- (01) Stay clear of danger zones - 600 feet above and 100 feet below dams.
  - (02) Approach dams at reduced speed, along the shore at the lock.
  - (03) Be "dam" conscious:
    - a) During the filling process, it is dangerous to approach near the intake ports in the lock walls above the upstream lock gates. The filling process creates a powerful suction as water rushes into the culverts. Boats must stay clear of the locks until signalled to approach.
    - b) During the emptying process, a strong undercurrent and suction is created in the lock chamber. This suction occurs next to the lock walls and is created by the water rushing into the filling and emptying ports of the lock.
  - (01) Wearing a PFD may not keep a person from being pulled under the water in these circumstances.
-



### H.5. Common River Sailing Terms

**Table 3-7** provides terms and their definitions, commonly used in river sailing.

<b>Term</b>	<b>Description</b>
Auxiliary Lock	A small secondary lock next to the main lock.
Backwater	The water backed up a tributary system.
Bar	A deposit of sand or gravel in or near the channels that, at times, prevents boat traffic from passing.
Bend	A bend of the river, similar to a curve in a highway.
Berm	The sharp definitive edge of a dredged channel, such as in a rock cut.
Bight of a Bend	Sharpest part of a curve in a river or stream.
Bits, Floating	Part of a lock system for securing a boat waiting in a lock, recessed in lock walls.
Boil	Turbulence in the water resulting from deep holes, ends of dikes, channel changes, or other underwater obstructions.
Caval or Kevel	A steel cleat of special design on barges and towboats for making aft mooring and towing lines.
Chute	Section of river that is narrower than ordinary and through which the river current increases. It is also the passage behind an island that is not the regular channel.
Deadhead	A water soaked wooden pile, tree, or log that floats at the surface of the water (barely awash), usually in a vertical position.
Dike	A structure of pilings or stone that diverts the current of a river.
Down Draft	The natural tendency of a river current to pull the boat downstream when making a river crossing.
Draft	A crosscurrent that is usually designated as an out draft, or as a left- or right-handed draft.
Draw Down	The release of water through one dam before the arrival of a significant increase in water from the upper reaches of the river.
Drift	Debris floating in or lodged along the banks of the river. (Also known as driftwood.)

**Table 3-7**  
**Common River Sailing Terms**



<b>Term</b>	<b>Description</b>
Flat Pool	The normal stage of water in the area between two dams. It is maintained when little or no water is flowing; therefore the pool flattens out.
Flood Stage	A predetermined level or stage along the main river bank where flooding will occur or may overflow in the particular area.
Foot of _____	The downstream end or lower part of a bend or island.
Gauge	A scale graduated in tenths of a foot that shows the water level or river stage. A lower gauge is one that shows the downstream side of a dam and an upper gauge is one on the upstream side.
Head of _____	The upstream end or beginning of a bend or island.
Left Bank	The left bank of a river when going downstream, properly termed left bank descending.
Levee	An embankment or dike constructed for flood protection.
Lock	A chamber built as part of a river dam to raise or lower boat traffic that wants to pass the dam.
Lock Gate	A moveable barrier that prevents water from entering or leaving a lock chamber.
Mile Board	A 12" x 36" board above a river aid and with the river mileage at that point from a given location.
Open River	Any river having no obstructions such as dams, or when the river stage is high enough to navigate over movable dams.
Pool Stage	The stage of water between two successive dams. It is usually at the minimum depth to maintain the depth in the channel at the shallowest point.
Reach	Usually a long, straight section of a river.
Right Bank	The right bank of a river when going downstream, properly termed as right bank descending.
Slack Water	A location where there is a minimum current.
Snag	Tree or log embedded in the river bottom.
Tow	One or more barges made up to be transported by a boat.
Towboat	A riverboat that pushes barges ahead.

**Table 3-8 (Continued)**  
**Common River Sailing Terms**





## APPENDIX A Glossary

---

**Introduction**

This appendix contains a list of terms that may be useful when reading this Manual.

---

**In this Appendix**

This appendix contains the following information:

Topic	See Page
Glossary	<a href="#">A-2</a>

---



TERM	DEFINITION
<b>Abeam</b>	To one side of a vessel, at a right angle to the fore-and-aft centerline.
<b>Aft</b>	Near or toward the stern.
<b>Aground</b>	With the keel or bottom of a vessel fast on the sea floor.
<b>Aids to Navigation (AtoN)</b>	Lighthouses, lights, buoys, sound signals, racon, radiobeacons, electronic aids, and other markers on land or sea established to help navigators determine position or safe course, dangers, or obstructions to navigation.
<b>Amidships</b>	In or towards center portion of the vessel, sometimes referred to as “midships.”
<b>Anchorage Area</b>	A customary, suitable, and generally designated area in which vessels may anchor.
<b>Astern</b>	The direction toward or beyond the back of a vessel.
<b>Beacon</b>	Any fixed aid to navigation placed ashore or on marine sites. If lighted, they are referred to as minor lights.
<b>Beam</b>	The widest point of a vessel on a line perpendicular to the keel, the fore-and-aft centerline.
<b>Beaufort Wind Scale</b>	A scale whose numbers define a particular state of wind and wave, allowing mariners to estimate the wind speed based on the sea state.
<b>Bell Buoy</b>	A floating aid to navigation with a short tower in which there are several clappers that strike the bell as it rocks with the motion of the sea.
<b>Below</b>	The space or spaces that are underneath a vessel’s main deck.
<b>Boat hook</b>	A hook on a pole with a pushing surface at the end used to retrieve or pick up objects, or for pushing objects away.
<b>Bow</b>	The forward end of the vessel.
<b>Breaker</b>	A wave cresting with the top breaking down over its face.
<b>Broadcast Notice to Mariners</b>	A radio broadcast that provides important marine information.
<b>Buoy</b>	A floating aid to navigation anchored to the bottom that conveys information to navigators by their shape or color, by their visible or audible signals, or both.
<b>Buoy Moorings</b>	Chain or synthetic rope used to attach buoys to sinkers.
<b>Buoy Station</b>	Established (charted) location of a buoy.
<b>Buoyage</b>	A system of buoys with assigned shapes, colors, or numbers.
<b>Can Buoy (Cylindrical)</b>	A cylindrical buoy, generally green, marking the left side of a channel or safe passage as seen entering from seaward, or from the north or east proceeding south or west.





TERM	DEFINITION
<b>Cardinal Marks</b>	Indicate the location of navigable waters by reference to the cardinal directions (N,E,S,W) on a compass.
<b>Centerline</b>	An imaginary line down the middle of a vessel from bow to stern.
<b>Characteristic</b>	The audible, visual, or electronic signal displayed by an aid to navigation to assist in the identification of an aid to navigation. Characteristic refers to lights, sound signals, racons, radiobeacons, and daybeacons.
<b>Chart</b>	A printed or electronic geographic representation generally showing depths of water, aids to navigation, dangers, and adjacent land features useful to mariners (See <i>Nautical Chart</i> ).
<b>Coastal</b>	At or near a coast.
<b>Combination Buoy</b>	A buoy that combines the characteristics of both sound and light.
<b>Compass</b>	An instrument for determining direction: magnetic, depending on the earth’s magnetic field for its force; gyroscopic, depending on the tendency of a free-spinning body to seek to align its axis with that of the earth.
<b>Conventional Direction of Buoyage</b>	The general direction taken by the mariner when approaching a harbor, river, estuary, or other waterway from seaward; or proceeding upstream or in the direction of the main stream of flood tide, or in the direction indicated in appropriate nautical documents (normally, following a clockwise direction around land masses).
<b>Course (C)</b>	The horizontal direction in which a vessel is steered or intended to be steered, expressed as angular distance from north, usually from 000° at north, clockwise through 360°.
<b>Coxswain</b>	Person in charge of a boat, pronounced “COX-un.”
<b>Current (Ocean)</b>	Continuous movement of the sea, sometimes caused by prevailing winds, as well as large constant forces, such as the rotation of the earth, or the apparent rotation of the sun and moon. Example is the Gulf Stream.
<b>Datum</b>	In SAR, refers to the probable location of a distressed vessel, downed aircraft, or PIW, which is corrected for drift at any moment in time. Depending on the information received this may be represented as a point, a line or an area.
<b>Day Mark</b>	The daytime identifier of an aid to navigation (see <i>Daybeacon, Dayboard</i> ).
<b>Daybeacon</b>	An unlighted fixed structure which is equipped with a highly visible dayboard for daytime identification.
<b>Dayboard</b>	The daytime identifier of an aid to navigation presenting one of several standard shapes (square, triangle, rectangle) and colors (red, green, white, orange, yellow or black).
<b>Dead-in-the-Water (DIW)</b>	A vessel that has no means to maneuver, normally due to engine casualty. A vessel that is adrift or no means of propulsion.
<b>Dead Reckoning (DR)</b>	Determination of estimated position of a craft by adding to the last fix the craft’s course and speed for a given time.



TERM	DEFINITION
<b>Direction of Current</b>	The direction toward which a current is flowing. See <i>set</i> .
<b>Direction of Waves, Swells, or Seas</b>	The direction to which the waves, swells, or seas are moving.
<b>Distress</b>	As used in the Coast Guard, when a craft or person is threatened by grave or imminent danger requiring immediate assistance.
<b>Dolphin</b>	A structure consisting of a number of piles driven into the seabed or river bed in a circular pattern and drawn together with wire rope. May be used as part of a dock structure or a minor aid to navigation. Commonly used when a single pile would not provide the desired strength.
<b>Draft</b>	The point on a vessel's underwater body, measured from the waterline, that reaches the greatest depth.
<b>Drift</b>	The rate/speed at which a vessel moves due to the effects of wind, wave, current, or the accumulative effects of each. Usually expressed in knots.
<b>Ebb</b>	A tidal effect caused by the loss of water in a river, bay, or estuary resulting in discharge currents immediately followed by a low tidal condition.
<b>Ebb Current</b>	The horizontal motion away from the land caused by a falling tide.
<b>Ebb Direction</b>	The approximate true direction toward which the ebbing current flows; generally close to the reciprocal of the flood direction.
<b>Eye</b>	The permanently fixed loop at the end of a line.
<b>Eye Splice</b>	The splice needed to make a permanently fixed loop at the end of a line.
<b>Fairways (Mid-Channel)</b>	A channel that is marked by safemarks that indicate that the water is safe to travel around either side of the red and white vertically striped buoy.
<b>Fixed Light</b>	A light showing continuously and steadily, as opposed to a rhythmic light.
<b>Flash</b>	A relatively brief appearance of light, in comparison with the longest interval of darkness in the same character.
<b>Flashing Light</b>	A light in which the total duration of light in each period is clearly shorter than the total duration of darkness and in which the flashes of light are all of equal duration. Commonly used for a single-flashing light which exhibits only single flashes which are repeated at regular intervals.
<b>Floating Aid to Navigation</b>	A buoy.
<b>Flood</b>	A tidal effect caused by the rise in water level in a river, bay, or estuary immediately followed by a high tidal condition.



TERM	DEFINITION
<b>Flood Current</b>	The horizontal motion of water toward the land caused by a rising tide.
<b>Flood Direction</b>	The approximate true direction toward which the flooding current flows; generally close to the reciprocal of the ebb direction.
<b>Forward</b>	Towards the bow of a vessel.
<b>Global Positioning System (GPS)</b>	A satellite-based radio navigation system that provides precise, continuous, worldwide, all-weather three-dimensional navigation for land, sea and air applications.
<b>Gong Buoy</b>	A wave actuated sound signal on buoys which uses a group of saucer-shaped bells to produce different tones. Found inside harbors and on inland waterways. Sound range about one mile.
<b>Group-Flashing Light</b>	A flashing light in which a group of flashes, specified in number, is regularly repeated.
<b>Group-Occulting Light</b>	An occulting light in which a group of eclipses, specified in number, is regularly repeated.
<b>Harbor</b>	Anchorage and protection for ships. A shelter or refuge.
<b>Heading</b>	The direction in which a ship or aircraft is pointed.
<b>Helm</b>	The apparatus by which a vessel is steered; usually a wheel or tiller.
<b>High Seas</b>	That body of water extending seaward of a country's territorial sea to the territorial sea of another country.
<b>Information Marks</b>	Aids to navigation that inform the mariner of dangers, restriction, or other information. Also referred to as regulatory marks.
<b>Inlet</b>	A recess, as a bay or cove, along a coastline. A stream or bay leading inland, as from the ocean. A narrow passage of water, as between two islands.
<b>Isolated Danger Mark</b>	A mark erected on, or moored above or very near, an isolated danger which has navigable water all around it.
<b>Junction</b>	The point where a channel divides when proceeding seaward. The place where a branch of a river departs from the main stream.
<b>Junction Aid (Obstruction Aid)</b>	Horizontally striped aids that indicate the preferred channel with the top color on the aid. They may also mark an obstruction.
<b>Keel</b>	The central, longitudinal beam or timber of a ship from which the frames and hull plating rise.
<b>Knot (kn or kt)</b>	A unit of speed equivalent to one nautical mile (6,080 feet) per hour. A measurement of a ship's speed through water. A collective term for hitches and bends.



TERM	DEFINITION
<b>Lateral Marks</b>	Buoys or beacons that indicate port and starboard sides of a route and are used in conjunction with a “Conventional direction of buoyage.”
<b>Lateral System</b>	A system of aids to navigation in which characteristics of buoys and beacons indicate the sides of the channel or route relative to a conventional direction of buoyage (usually upstream).
<b>Lateral System of Buoyage</b>	<i>See lateral system.</i>
<b>Latitude</b>	The measure of angular distance in degrees, minutes, and seconds of arc from 0° to 90° north or south of the equator.
<b>Light</b>	The signal emitted by a lighted aid to navigation. The illuminating apparatus used to emit the light signal. A lighted aid to navigation on a fixed structure.
<b>Light Buoy</b>	A floating framework aid to navigation, supporting a light, usually powered by battery.
<b>Light List</b>	A United States Coast Guard publication (multiple volumes) that gives detailed information on aids to navigation.
<b>Light Rhythms</b>	Different patterns of lights, and flashing combinations that indicate to the mariner the purpose of the aid to navigation on which it is installed.
<b>Light Sector</b>	The arc over which a light is visible, described in degrees true, as observed from seaward towards the light. May be used to define distinctive color difference of two adjoining sectors, or an obscured sector.
<b>Lighthouse</b>	A lighted beacon of major importance. Fixed structures ranging in size from the typical major seacoast lighthouse to much smaller, single pile structures. Placed onshore or on marine sites and most often do not show lateral aid to navigation markings. They assist the mariner in determining his position or safe course, or warn of obstructions or dangers to navigation. Lighthouses with no lateral significance usually exhibit a white light, but can use sectored lights to mark shoals or warn mariners of other dangers.
<b>Local Notice to Mariners</b>	A written document issued by each U.S. Coast Guard District to disseminate important information affecting aids to navigation, dredging, marine construction, special marine activities, and bridge construction on the waterways with that district.
<b>Longitude</b>	A measure of angular distance in degrees, minutes, and seconds east or west of the Prime Meridian at Greenwich.
<b>Lookout</b>	A person stationed as a visual watch.
<b>Magnetic Compass</b>	A compass using the earth’s magnetic field to align the compass card. ( <i>see compass</i> )
<b>Magnetic Course (M)</b>	Course relative to magnetic north; compass course corrected for deviation.
<b>Maritime</b>	Located on or close to the sea; of or concerned with shipping or navigation.
<b>Mark</b>	A visual aid to navigation. Often called navigation mark, includes floating marks (buoys) and fixed marks (beacons).



TERM	DEFINITION
<b>Mid-Channel</b>	Center of a navigable channel. May be marked by safemarks.
<b>Modified U.S. Aid System</b>	Used on the Intracoastal Waterway, these aids are also equipped with special yellow strips, triangles, or squares. When used on the western rivers (Mississippi River System), these aids are not numbered (Mississippi River System above Baton Rouge and Alabama Rivers).
<b>Mooring</b>	A chain or synthetic line that attaches a floating object to a stationary object. (e.g., dock, sinker)
<b>Mooring Buoy</b>	A white buoy with a blue stripe, used for a vessel to tie up to, also designates an anchorage area.
<b>Nautical Chart</b>	Printed or electronic geographic representation of waterways showing positions of aids to navigation and other fixed points and references to guide the mariner.
<b>Nautical Mile (NM)</b>	2000 yards; Length of one minute of arc of the great circle of the earth; 6,076 feet compared to 5,280 feet per a statute (land) mile.
<b>Nautical Slide Rule</b>	An instrument used to solve time, speed, and distance problems.
<b>Navigable Channel</b>	A channel that has sufficient depth to be safely navigated by a vessel.
<b>Navigable Waters</b>	Coastal waters, including bays, sounds, rivers, and lakes, that are navigable from the sea.
<b>Navigation</b>	The art and science of locating the position and plotting the course of a ship or aircraft
<b>Noise</b>	The result of the propeller blade at the top of the arc transferring energy to the hull.
<b>Nun Buoy (Conical)</b>	A buoy that is cylindrical at the waterline, tapering to a blunt point at the top. Lateral mark that is red, even numbered, and usually marks the port hand side proceeding to seaward.
<b>Obstruction Aid</b>	<i>See junction aid.</i>
<b>Occluding Light</b>	A light in which the total duration of light in each period is clearly longer than the total duration of darkness and in which the intervals of darkness are all of equal duration. (Commonly used for single-occluding light which exhibits only single occultations that are repeated at regular intervals.)
<b>Offshore</b>	The region seaward of a specified depth. Opposite is inshore or near-shore.
<b>On Scene</b>	The search area or the actual distress site.
<b>Piling</b>	A long, heavy timber driven into the seabed or river bed to serve as a support for an aid to navigation or dock.
<b>Port</b>	The left side of the vessel looking forward toward the bow.
<b>Preferred Channel Mark</b>	A lateral mark indicating a channel junction, or a wreck or other obstruction which, after consulting a chart, may be passed on either side.
<b>Preventer Line (Preventer)</b>	Any line used for additional safety or security or to keep something from falling or running free.



TERM	DEFINITION
<b>Primary Aid to Navigation</b>	An aid to navigation established for the purpose of making landfalls and coastwise passages from headland to headland.
<b>Proceeding From Seaward</b>	Following the Atlantic coast in a southerly direction, northerly and westerly along the Gulf coast and in a northerly direction on the Pacific coast. On the Great Lakes proceeding from seaward means following a generally westerly and northerly direction, except on Lake Michigan where the direction is southerly. On the Mississippi and Ohio Rivers and their tributaries, proceeding from seaward means from the Gulf of Mexico toward the headwaters of the rivers (upstream).
<b>Quarantine Anchorage Buoy</b>	A yellow special purpose buoy indicating a vessel is under quarantine.
<b>RACON</b>	See <i>radar beacon</i> .
<b>Radar</b>	Radio detecting and ranging . An electronic system designed to transmit radio signals and receive reflected images of those signals from a “target” in order to determine the bearing and distance to the ‘target.’”
<b>Radar Beacon (RACON)</b>	A radar beacon that produces a coded response, or radar paint, when triggered by a radar signal.
<b>Radar Reflector</b>	A special fixture fitted to or incorporated into the design of certain aids to navigation to enhance their ability to reflect radar energy. In general, these fixtures will materially improve the aid to navigation for use by vessels with radar. They help radar equipped vessels to detect buoys and beacons. They do not positively identify a radar target as an aid to navigation. Also used on small craft with low radar profiles.
<b>Radiobeacon</b>	An electronic apparatus which transmits a radio signal for use in providing a mariner a line of position. First electronic system of navigation. Provided offshore coverage and became the first all-weather electronic aid to navigation.
<b>Range</b>	A measurement of distance usually given in yards. Also, a line formed by the extension of a line connecting two charted points.
<b>Range Lights</b>	Two lights associated to form a range which often, but not necessarily, indicates a channel centerline. The front range light is the lower of the two, and nearer to the mariner using the range. The rear range light is higher and further from the mariner.
<b>Range Line</b>	The lining up of range lights and markers to determine the safe and correct line of travel, the specific course to steer to remain in the center of the channel.
<b>Range Marker</b>	High visibility markers that have no lights (see <i>range lights</i> ).
<b>Red, Right, Returning</b>	A saying to remember which aids a crewmember should be seeing off vessel’s starboard side when returning from seaward.
<b>Regulatory Marks</b>	A white and orange aid to navigation with no lateral significance. Used to indicate a special meaning to the mariner, such as danger, restricted operations, or exclusion area.



TERM	DEFINITION
<b>Retroreflective Material</b>	Material that reflects light. Can be found on equipment such as PFDs or hypothermia protective clothing.
<b>Riprap</b>	Stone or broken rock thrown together without order to form a protective wall around a navigation aid.
<b>Route</b>	A sequence of waypoints establishing a track to navigate from point A to point B.
<b>Rudder</b>	A flat surface rigged vertically astern used to steer a ship, boat, or aircraft.
<b>Safe Water Marks (Fairways, Mid-Channels)</b>	Used to mark fairways, mid-channels, and offshore approach points, and have unobstructed water on all sides. They may have a red spherical shape, or a red spherical topmark, are red and white vertically striped, and if lighted, display a white light with Morse code “A” (short-long flash).
<b>Seaman’s Eye</b>	To estimate your position without navigational instruments by utilizing distances and angles obtained from instinctive knowledge and experience of the local maritime environment.
<b>Seaward</b>	Toward the main body of water, ocean. On the Intracoastal Waterway, returning from seaward is from north to south on the eastern U.S. coast, east to west across the Gulf of Mexico, and south to north along the western seacoast.
<b>Set (of a Current)</b>	The direction toward which the water is flowing. A ship is set by the current. A southerly current and a north wind are going in the same direction. Measured in degrees (usually true).
<b>Shaft</b>	A cylindrical bar that transmits energy from the engine to the propeller.
<b>Ship</b>	Any vessel of considerable size navigating deepwater, especially one powered by engines and larger than a boat. Also, to set up, to secure in place. To take something aboard.
<b>Short-Range Aids to Navigation</b>	Aids to navigation limited in visibility to the mariner (e.g., lighthouses, sector lights, ranges, LNBs, buoys, daymarks, etc.).
<b>Sinkers</b>	Concrete anchors in various sizes and shapes on the seabed that buoy bodies are attached to by chain or synthetic rope moorings.
<b>Siren</b>	A sound signal which uses electricity or compressed air to actuate either a disc or a cup-shaped rotor.
<b>Slack Water</b>	The period that occurs while the current is changing direction and has no horizontal motion.
<b>Sonar</b>	See Dept Sounder.
<b>Sound Buoys</b>	Buoys that warn of danger; they are distinguished by their tone and phase characteristics.
<b>Sound Signal</b>	A device that transmits sound, intended to provide information to mariners during periods of restricted visibility and foul weather; a signal used to communicate a maneuver between vessels in sight of each other.



TERM	DEFINITION
<b>Special Purpose Buoys</b>	Also called special marks, they are yellow and are not intended to assist in navigation, but to alert the mariner to a special feature or area.
<b>Square Daymarks</b>	Seen entering from seaward or from north or east proceeding south or west on port hand side of channel (lateral system of buoyage). Green, odd numbered.
<b>Starboard</b>	The right side of the vessel looking forward toward the bow.
<b>Starboard Hand Mark</b>	A buoy or beacon which is left to the starboard hand when proceeding in the “conventional direction of buoyage.” Lateral marks positioned on the right side of the channel returning from seaward. Nun buoys are red, daybeacons are red, bordered with dark red and triangular shaped.
<b>Station Buoy</b>	An unlighted buoy set near a large navigation buoy or an important buoy as a reference point should the primary aid to navigation be moved from its assigned position.
<b>Steerage</b>	The act or practice of steering. A ship’s steering mechanism.
<b>Steerageway</b>	The lowest speed at which a vessel can be steered.
<b>Stern</b>	The extreme after end of a vessel.
<b>Strut</b>	An external support for the propeller shaft integral to the hull/under water body.
<b>Superstructure</b>	Any raised portion of a vessel’s hull above a continuous deck (e.g., pilot house).
<b>Surf</b>	Waves or swells breaking on shore, shoals, reefs, bars or inlet.
<b>Tidal Current</b>	The horizontal motion of water caused by the vertical rise and fall of the tide.
<b>Tide</b>	The periodic vertical rise and fall of the water resulting from the gravitational interactions between the sun, moon, and earth.
<b>Topmarks</b>	One or more relatively small objects of characteristic shape and color placed on an aid to identify its purpose. (i.e., pillar buoys surmounted with colored shapes).
<b>Track</b>	The path of intended travel with respect to the earth as drawn on the chart. Also called Trackline.
<b>Transom</b>	Planking across the stern of a vessel.
<b>Triangular Daymark</b>	Entering from seaward, or from the north or east proceeding south or west on starboard hand side of channel (lateral system of buoyage). Red, even numbered.
<b>U.S. Aids to Navigation System</b>	A system that encompasses buoys and beacons conforming to (or being converted to) the IALA buoyage guidelines and other short-range aids to navigation not covered by these guidelines. These other aids to navigation are lighthouses, sector lights, ranges, and large navigation buoys (LNBs).





TERM	DEFINITION
<b>Uniform State Waterway Marking System (USWMS)</b>	Designed for use on lakes and other inland waterways that are not portrayed on nautical charts. Authorized for use on other waters as well. Supplemented the existing federal marking system and is generally compatible with it.
<b>Venturi Effect</b>	To move water from one place to another by entraining the pumped liquid in a rapidly flowing stream. It is the principle used by the eductor in dewatering a vessel.
<b>Vessel</b>	By U.S. statutes, includes every description of craft, ship or other contrivance used as a means of transportation on water. “Any vehicle in which man or goods are carried on water.” (see <i>ship</i> )
<b>Waist and/or Tag Line</b>	Lines used to secure the hull or cabin bridles in position for towing.
<b>Wake</b>	The disturbed water astern of a moving vessel.
<b>Watch Circle</b>	The circle in which an anchored buoy or object moves on the surface in relationship to tides, currents and wind.
<b>Watertight Integrity</b>	The closing down of openings to prevent entrance of water into vessel.
<b>Wave</b>	A periodic disturbance of the sea surface, caused by wind (and sometimes by earthquakes).
<b>Wave Frequency</b>	The number of crests passing a fixed point in a given time.
<b>Wave Height</b>	The height from the bottom of a wave’s trough to the top of its crest; measured in the vertical, not diagonal.
<b>Wave Interference</b>	Caused by waves, refracted or reflected, interacting with other waves, often increasing or decreasing wave height.
<b>Wave Length</b>	The distance from one wave crest to the next in the same wave group or series.
<b>Wave Period</b>	The time, in seconds, it takes for two successive crests to pass a fixed point.
<b>Wave Reflection</b>	The tendency of a wave to move back towards the incoming waves in response to interaction with any obstacle.
<b>Wave Refraction</b>	The tendency of a wave to bend in response to interaction with the bottom and slows in shoal areas. Refraction also occurs when a wave passes around a point of land, jetty, or an island.
<b>Wave Saddle</b>	The lowest part of a wave, bordered on both sides by higher ones; often small, unbroken section of a wave that is breaking.
<b>Wave Series</b>	A group of waves that seem to travel together, at the same speed.
<b>Wave Shoulder</b>	The edge of a wave. It may be the very edge of the whitewater on a breaker, or the edge of a high peaking wave that is about to break.
<b>Waypoint</b>	A set of coordinates that identify a specific location; an intermediate point or place on a route or track.



TERM	DEFINITION
<b>Wedge</b>	Used as temporary repair in event of damage aboard vessel. Made of soft wood, they are forced into holes or damaged areas to stop leaking, to plug damaged structures, or to reinforce shoving. Part of a damage control kit.
<b>Well Deck</b>	Part of the weather deck having some sort of superstructure both forward and aft of it. A vertically recessed area in the main deck that allows the crewmember to work low to the water.
<b>Wet Suit</b>	A tight-fitting rubber suit worn by a skin diver in order to retain body heat. Designed to protect wearer from exposure to cold, wind, and spray. Constructed of foam neoprene, a durable and elastic material with excellent flotation characteristics. These buoyancy characteristics, which affect the entire body, will cause floating horizontally, either face up or face down.
<b>Whistle</b>	A piece of survival equipment used to produce a shrill sound by blowing on or through it. To summon, signal or direct by whistling. A device for making whistling sounds by means of forced air or steam. A whistling sound used to summon or command. It is attached to some PFDs and is an optional item for the personal signal kit. It has proven very useful in locating survivors in inclement weather and can be heard up to 1,000 yards.
<b>Whistle Buoy</b>	A wave actuated sound signal on buoys which produces sound by emitting compressed air through a circumferential slot into a cylindrical bell chamber. Found outside harbors. Sound range greater than 1 mile.
<b>White Water</b>	<i>See foam crest.</i>
<b>Williamson Turn</b>	Used if an individual or object falls overboard during periods of darkness or restricted visibility and the exact time of the incident is unknown. Done by turning 60° to port or starboard from the original course, there shifting rubber until vessel comes about on a reverse course. May be of little value to boats having a small turning radius.
<b>Wind-Chill Factor</b>	An estimated measurement of the cooling effect of a combination of air temperature and wind speed in relation to the loss of body heat from exposed skin.
<b>Wind Direction</b>	The true heading from which the wind blows.
<b>Wind-Driven Current</b>	The effect of wind pushing water in the direction of the wind.
<b>Window</b>	An area where the waves have momentarily stopped breaking, opening up a safer area of operation for a vessel.
<b>Wind Shadow</b>	When an object blocks the wind, creating an area of no wind.
<b>Windward</b>	Towards the wind.
<b>Yaw</b>	Rotary oscillation about a ship's vertical axis in a seaway. Sheering off alternately to port and starboard.



## APPENDIX B List of Acronyms

**Introduction** This appendix contains a list of acronyms that may be useful when reading this and other Coast Guard manuals.

---

**In this Appendix** This appendix contains the following information:

Topic	See Page
List of Acronyms	B-2

---



ACRONYM	DEFINITION
A/C	Air Conditioning
AAR	After Action Report
ACFT	Aircraft
ACIP	Aviation Incentive Pay
ACMS	Aviation Computerized Maintenance System
ACP	Area Contingency Plan
ACP	Alternate Compliance Program
ACTSUS	Active Suspension
ADF	Automatic Radio Direction Finder
ADSW-AC	Active Duty Special Work in Support of Active Component
ADT	Active Duty for Training
ADT-AT	Active Duty Training for Annual Training
AEO	Assistant Engineering Officer
AEPO	Assistant Engineering Petty Officer
AFC	Allowance Fund Control
AFFF	Aqueous Film – Forming Foam
AIDS	Acquired Immunodeficiency Syndrome
AIM	Administrative Investigations Manual
AIS	Automatic Identification System
AH	Amplitude Modulation
AMIO	Alien/Migrant Interdiction Operation
AMS	Automated Manifest System
AMVER	Automated Mutual-Assistance Vessel Rescue
ANB	Aids to Navigation Boat
ANS	Aquatic Nuisance Species
ANSI	American National Standards Institute
ANT	Aids to Navigation Team
AOPS	Abstract of Operations
AOR	Area of Responsibility
API	American Petroleum Institute
APPS	Act to Prevent Pollution from Ships
APR	Aid Positioning Report



ACRONYM	DEFINITION
ASB	Arctic Survey Boat
ATB	Aviation Training Boat
AtoN	Aids to Navigation
AtoNIS	Aids to Navigation Information System
ATR	Ammunition Transaction Report
AUXCOM	Auxiliary Boat Commander
AUX DATA	Auxiliary Data
AUXPATCOM	Auxiliary Patrol Commander
AV	Aid Verifier
BA	Bridge Administration
BAC	Blood Alcohol Content
BAS	Basic Allowance for Subsistence
BCEB	Boat Crew Examination Boards
BCM	Boat Crewmember
BCMP	Boat Class Maintenance Plan
BDCM	Buoy Deck Crewmember
BDS	Buoy Deck Supervisor
BECCE	Basic Engineering Casualty Control Exercises
BEQ	Bachelor Enlisted Quarters
BM	Boatswain's Mate
BNTM	Broadcast Notice to Mariners
BO	Boarding Officer
BO/BTM PQS	Boarding Officer / Boarding Team Member Personnel Qualification Standard
BOSN	Boatswain
BS	Breaking Strength
BSC	Boating Safety Circular
BTM	Boarding Team Member
BUSL	Buoy Utility Stern Loading
BWI	Boating While Intoxicated
BWM	Ballast Water Management
C2	Command and Control
C2PC	Command/Control Personal Computer
CABs	Compressions, Airway, and Breathing



ACRONYM	DEFINITION
CAC	Crisis Action Center
CASCOR	Casualty Correct
CASREP	Casualty Report
CBL	Commercial Bill of Lading
CB-L	Cutter Boat – Large
CB-M	Cutter Boat – Medium
CB-OTH	Cutter Boat – Over the Horizon
CBRN	Chemical, Biological, Radiological, Nuclear
CB-S	Cutter Boat – Small
CDAR	Collateral Duty Addictions Representative
CDI	Course Deviation Indicator
CDO	Command Duty Officer
CDR	Commander
CDV	Course Deviation Variance
CEM	Crew Endurance Management
CERCLA	Comprehensive Environment Compensation and Liability Act
CEU	Civil Engineering Unit
CF	Comparison Factors
CFC	Combined Federal Campaign
CFR	Code of Federal Regulations
CFVS	Commercial Fishing Vessel Safety
CGADD	Coast Guard Addendum
CGDF	Coast Guard Dining Facility
CGIS	Coast Guard Investigative Service
CGPC	Coast Guard Personnel Command
CIC	Combat Information Center
CIO	Command Intelligence Officer
CISM	Critical Incident Stress Management
CM	Configuration Management
CMAA	Chief Master at Arms
CMCO	Classified Material Control Officer
CMG	Course Made Good
CMS	COMSEC (Communication Security) Material System



ACRONYM	DEFINITION
CO	Commanding Officer or Carbon Monoxide
CO/OIC	Commanding Officer/Officer-in-Charge
COCO	Chief of Contracting Officer
COFR	Certificate of Financial Responsibility
COG	Course Over Ground
COI	Certificate of Inspection
COLREG	International Regulations for Preventing Collisions at Sea
COMCEN	Communications Center
COMDTINST	Commandant Instruction
COMINT	Communications Intelligence
COMMS	Communications
CONOPS	Concept of Operations
COR	Certificate of Registry
COTP	Captain-of-the-Port
COTR	Contracting Officer’s Technical Representative
CPC	Commandant’s Performance Challenge
CPO	Chief Petty Officer
CPR	Cardiopulmonary Resuscitation
CPU	Central Processing Unit
CQA	Commandant’s Quality Award
CRT	Cathode Ray Tube
CS	Creeping Line Search
CSIM	Control Station Interface Module
CSMP	Current Ship’s Maintenance Project
CSP	Commence Search Point
CSP	Career Sea Pay
CVE	Control Verification Examination
CVS	Commercial Vessel Safety
CWO	Chief Warrant Officer
DAMA	Demand Assigned Multiple Access
DAN	Driver’s Alert Network
DANTES	Defense Activity for Non-Traditional Education Support
DAPA	Drug and Alcohol Program Administration



ACRONYM	DEFINITION
DDEC	Detroit Diesel Electronically Controlled
DEER	Defense Enrollment and Eligibility Reporting System
DEMPs	Diesel Engine Maintenance Programs
DF	Direction Finding
DGPS	Differential Global Positioning System
DICP	Drop-In Communications Package
DISREP	Discrepancy Report
DISREPS	Discrepancy Report
DIW	Dead-in-the-Water
DMA	Defense Mapping Agency
DMB	Data Marker Buoy
DMOA	Designated Medical Officer Advisor
DMS	Docket Management System
DO	Defense Operations
DoD	Department of Defense
DONCAF	Department of the Navy Central Adjudication Facility
DOT	Department of Transportation
DPB	Deployable Pursuit Boat
DR	Dead Reckoning
DSC	Digital Selective Calling
DVL	Digital Voice Logger
DWO	Deck Watch Officer
DWONR	Deck Watch Officer Navigation Rules
EAP	Employee Assistance Program
EAPC	Employee Assistance Program Coordinator
EBL	Electronic Bearing Line
EC	Electronic Control
EC	Engineering Change
ECM	Electronic Control Module
ECR	Engineering Change Request
ECS	Electronic Chart System
EDF	Enlisted Drug Facilities
EDM	Electronic Display Module





ACRONYM	DEFINITION
EEZ	Exclusive Economic Zone
EGIM	Electronic Gear Interface Module
ELC	Engineering Logistics Center
ELINT	Electronics Intelligence
ELT	Emergency Locator Transmitter
ELT	Enforcement of Laws and Treaties
EMI	Extra Military Instruction
EMS	Emergency Medical Services
EMT	Emergency Medical Technician
EO	Engineering Officer
EOCT	End-of-Course Test
EP	Estimated Position
EPA	Environmental Protection Agency
EPES	Enlisted Personnel Evaluation System
EPIRB	Emergency Position Indicating Radio Beacon
EPO	Engineering Petty Officer
EPO/EO	Engineering Petty Officer/Engineering Officer
EPS	Environmental Protection Specialist
ERIM	Engine Room Interface Module
ESA	Endangered Species Act
ESD	Electronics Support Detachment
ESU/D	Electronics Support Unit/detachment
ET	Electronics Technician
ETA	Electronic Transportation Acquisition
ETA	Estimated Time of Arrival
EXCOM	Extended Communications
FAA	Federal Aviation Agency
FAR	Family Advocacy Representative
FAR	Federal Acquisition Regulations
FAST	Facial Drooping, Arm Weakness, Speech Difficulty, and Time is Critical
FBIS	Foreign Broadcast Information Service
FEDEX	Federal Express
FEEF	Federal Energy Efficiency Funding



ACRONYM	DEFINITION
FFCS	Full Function Crew Station
FID	Field Information Document
FINCEN	Finance Center
FIR	Field Intelligence Report
FL	Fitness Leader
FLOCS	Fast Lubricating Oil Change System
FLS	Fleet Logistics Supply
FM	Frequency Modulation
FMP	Fisheries Management Plan
FOIA	Freedom of Information Act
FOSC	Federal On-Scene Coordinator
FOUO	For Official Use Only
FPCON	Force Protection Conditions
FPM	Feet Per Minute
FRP	Fiberglass Reinforced Plastic
FS	Food Service Specialist
FSC	Federal Supply Classification
FSI	Field Sobriety Test
FSIC	Fiscal, Sanitation, Immigration or Customs
FSO	Food Services Officer
FWPCA	Federal Water Pollution Control Act
FWS	Fish and Wildlife Service
GAR	Green-Amber-Red
GFM	Global Freight Management
GMDSS	Global Maritime Distress and Safety System
G-OCS	Office of Boat Forces
G-OI	Office of Intelligence
GPH	Gallons Per Hour
GPS	Global Positioning System
GRUCOM	Group Commander
GSA	Government Service Administration
GTA	Government Transportation Account
GV	Government Vehicle



ACRONYM	DEFINITION
HAZCOM	Hazardous Communication
HAZMAT	Hazardous Material
HAZWASTE	Hazardous Waste
HCPV/HIV	High Capacity Passenger Vessel/High Interest Vessel
HDOP	Horizontal Dilution of Precision
HEA	Harbor Entrance and Approach
HELP	Heat Escape Lessening Position
HF	High Frequency
HIN	Hull Identification Number
HIV	Human Immunodeficiency Virus
HS	Homeland Security
HPU	Hydraulic Power Unit
HRSIC	Human Resources Services and Information Center
HSC	Harbor Safety Committee
HUMINT	Human Intelligence
HVAC	Heating, Ventilation, and Air Conditioning
IACS	International Association of Classification Societies
IALA	International Association of Lighthouse Authorities
IAMSAR	International Aeronautical and Maritime Search and Rescue
I-AtoNIS	Integrated Aids to Navigation Information Systems
ICA	Individual Credit Accounts
ICAO	International Civil Aviation Organization
ICC	Intelligence Coordination Center
ICLL	International Convention on Load Lines
ICMTS	Interagency Committee of the Marine Transportation System
ICS	Incident Command System
ICV	Intercommunicating Fill Valve
ICW	Intracoastal Waterway
IDT	Inactive Duty for Training
IEC	International Electrotechnical Commission
IIP	International Ice Patrol
IIR	Intelligence Information Report
IIRAIRA	Illegal Immigration Reform and Immigrant Responsibility Act



ACRONYM	DEFINITION
ILO	International Labor Organization
IMARV	Independent Maritime Response Vessel
IMO	International Maritime Organization
IMPAC	International Merchant Purchase Authorization Card
INA	Immigration and Nationality Act
INS	Immigration and Naturalization Service
IPIECA	International Petroleum Industry Environmental Conservation Association
IPS	International Pipe Standard
IRIS	Incident Reporting Information System
ISC	Integrated Support Command
ISM	International Ship Management
ISO	International Standards Organization
IT	Information Systems Technician
IUU	Illegal, Unreported, and Unregulated
JOOD	Junior Officer of the Day
JQR	Job Qualification Requirement
KO	Contracting Officer
LC	Load Center
LCD	Liquid Crystal Display
LCVP	Landing Craft, Vehicle, Personnel
LE	Law Enforcement
LEISII	Law Enforcement Information System II
LEMAN	Law Enforcement Manual
LEO	Law Enforcement Officer
LEQB	Law Enforcement Qualification Board
LEU	Law Enforcement Unit
LHA	Local Housing Authority
LHI	Local Housing Inspector
LIR	Letter Incident Report
LKP	Last Known Position
LLNR	<i>Light List</i> Number
LMR	Living Marine Resource
LNB	Large Navigation Buoy



ACRONYM	DEFINITION
LNG	Liquid Natural Gas
LOA	Length Overall
LOB	Line-of-Bearing
LOC	Letter of Commendation or Level of Consciousness
LOGREQ	Logistics Requirements
LOP	Line of Position
LORAN-C	Long-Range Aid to Navigation
LORSTA	LORAN Station
LOS	Line-of-Sight
LUFS	Large Unit Financial System
LUT	Local User Terminal
LWL	Length on Waterline
MAA	Master at Arms
MARB	Maritime Assistance Request Broadcast
MARPOL	International Convention for the Prevention of Pollution from Ships
MARSEC	Marine Security Conditions
MASINT	Measurement and Signature Intelligence
MAW	Maximum Allowable Weight
MBR INT	Member's Initials
MCB	Motor Cargo Boat
MCM	Manual for Courts-Martial
MCS	Master Control Station
MDA	Maritime Domain Awareness
MDV	Marine Dealer Visit
MDZ	Maritime Defense Zone
MEDICO	Medical Advice
MEDEVAC	Medical Evacuation
MEP	Marine Environmental Protection
MEPC	Marine Environment Protection Committee
MER	Marine Environmental Response
MF	Medium Frequency
MFPU	Maritime Force Protection Unit
MHS	Maritime Homeland Security



<b>ACRONYM</b>	<b>DEFINITION</b>
MI	Marine Information
MI	Maintenance Inspection
MI & R	Maintenance, Improvement and Repair
MIC	Manufacturer Identification Code
MICA	Management Information for Configuration and Allowances
MICA	Machinery Information Catalog Allowance
MIM	Marine Interface Module
MISLE	Marine Information for Safety and Law Enforcement
MJM	Military Justice Manual
MLB	Motor Lifeboat
MLC	Maintenance and Logistics Command
MLCPAC	Maintenance and Logistics Command Pacific
MMD	Merchant Mariner Document
MMPA	Marine Mammal Protection Act
MMS	Minerals Management Services
MMSI	Maritime Mobile Service Identity
MOA	Memorandum of Agreement
MOB	Man Overboard
MOU	Memorandum of Understanding
MPR	Multiple Persons-in-the-Water
MPS	Marine Protected Species
MRE	Military Rule of Evidence
MRR	Medium-Range Recovery
MSAP	Maritime SAR Assistance Policy
MSB	Motor Surf Boat
MSC	Marine Safety Center
MSFCMA	Magnuson-Stevens Fisheries Conservation and Management Act
MSO	Maintenance Support Outline
MSO	Marine Safety Office
MSS	Marine Safety and Security
MSST	Maritime Safety and Security Team
MTL	Master Training List
MTS	Marine Transportation System



ACRONYM	DEFINITION
MTSNAC	Marine Transportation System National Advisory Council
MWR	Moral, Welfare and Recreation
NAFA	Non-Appropriated Fund Activity
NAVAIDS	Navigational Aids
NAVRULS	Navigation Rules
NCP	National Contingency Plan
NCW	Naval Coastal Warfare
NDRS	National Distress Response System
NDRSMP	National Distress Response System Modernization Project
NDS	National Distress System
NESU	Naval Engineering Support Unit
NJP	Non-Judicial Punishment
NLB	Nearshore Life Boat
NLT	No Later Than
NM	Nautical Miles
NMEA	National Marine Electronics Association
NMFS	National Marine Fisheries Service
NMLBS	National Motor Lifeboat School
NOS	National Ocean Survey
NOAA	National Oceanic and Atmospheric Administration
NRC	National Response Center
NRT	National Response Team
NSARC	National Search and Rescue Committee
NSB	Non-Standard Boat
NSF	National Strike Force
NSFCC	National Strike Force Coordination Center
NSN	National Stock Number
NSP	National Search and Rescue Plan
NSS	National Search and Rescue Supplement
NTP	Naval Training Publication
NVDC	National Vessel Documentation Center
NVIC	Navigation and Vessel Inspection Circular
NWP	Naval Warfare Publication



ACRONYM	DEFINITION
OBA	Oxygen Breathing Apparatus
O/S WX	On-Scene Weather
OCMI	Officer-in-Charge Marine Inspection
OER	Officer Evaluation Report
OIC	Officer-in-Charge
OIC INT	Officer in Charge's Initials
OJT	On-the-Job Training
OM & S	Operating Materials and Supplies
OMMP	Occupational Medical Monitoring Program
OOD	Officer of the Deck (Day)
OPA	Oil Pollution Act
OPAREA	Operational Area
OPCEN	Operations Center
OPCON	Operational Control
OPFAC	Operating Facility
OPLAN	Operations Plan
OPORD	Operations Order
OPORDER	Operations Order
OQB	Operations Qualification Board
ORM	Operational Risk Management
OS	Operations Specialist
OSB	Operations Standards Board
OSC	Operations Systems Center
OSC	On-Scene Commander
OSHA	Occupational Safety and Health Administration
OTC	Officer in Tactical Command
PA	Privacy Act
PAL	Personnel Allowance List
PALMS	Patrol Order Management System
PAO	Public Affairs Officer
PATCOM	Patrol Commander
PAWSS	Ports and Waterways Safety System
PCS	Permanent Change of Station





ACRONYM	DEFINITION
PDD	Presidential Decision Directive
PDR	Personnel Data Record
PDS	Personnel Data System
PERSRU	Personnel Reporting Unit
PES	Port and Environmental Safety
PFD	Personal Flotation Device
PI	Personnel Inspection
PIAT	Public Information Assistance Team
PIE	Partnership in Education
PIW	Person-in-the-Water
PLB	Personal Locator Beacon
PMIS/JUMPS	Personnel Management Information System/Joint Uniform Military Pay System
PMLV	Personnel Marker Light
PMS	Preventative/Planned Maintenance System
PO	Petty Officer
POB	Persons Onboard
POD	Probability of Detection
POP	Planned Obligation Priority
POS	Probability of Success
POPFAC	Parent Operating Facility
POW	Plan of the Week
PPE	Personal Protective Equipment
PPI	Plan Position Indicator
PPS	Precise Positioning Service
PQS	Personnel Qualification Standard
PR	Position Report
PRECOM	Preliminary Communications
PREP	Preparedness for Response Exercise Program
PS	Parallel Search
PSCO	Port State Control Officer
PSU	Port Security Unit
PTO	Power Take-Off
PWB	Port and Waterways Boat



ACRONYM	DEFINITION
PWSA	Ports and Waterway Safety Act
QAWTD	Quick-Acting Watertight Door
QEB	Qualification Examining Board
QRC	Quick Response Card
RACON	Radar Beacon
RB-HS	Response Boat-Homeland Security
RB-M	Response Boat-Medium
RBS	Recreational Boating Safety
RB-S	Response Boat-Small
RCC	Rescue Coordination Center
RDF	Radio Direction Finder
RFMC	Regional Fisheries Management Council
RFMO	Regional Fisheries Management Organization
RFO	Ready for Operations
RIK	Rations-In-Kind
RMS	Readiness Management System
RNAV	Radio Aids to Navigation
ROC/POE	Required Operational Capability/Point of Entry
RP	Responsible Party
RPAL	Reserve Personnel Allowance List
RS	Rescue Swimmer
RSC	Rescue Sub-Center
RT	Receiver/Transmitter
SAFE	Substance Abuse Free Environment
SAI	Small Arms Instructor
SAP	Simplified Acquisition Procedures
SAR	Search and Rescue
SAREX	SAR Exercise
SARMIS	Search and Rescue Mission Information System
SARSAT	Search and Rescue Satellite Aided Tracking
SAT	Subsistence Advisory Team
SATCOM	Satellite Communication
SB	Sailboat



ACRONYM	DEFINITION
SC	SAR Coordinator
SCUBA	Self-Contained Underwater Breathing Apparatus
SDB	Service Dress Blue
SDO	Sector Duty Officer
SEAOP	Special and Emergency Operations Procedure
SEPRATS	Separate Rations
SF	Safety Factor
SIGINT	Signals Intelligence
SIPRNET	Secret Internet Protocol Routing Network
SITREP	Situation Report
SKF	Skiff
SLDMB	Self Locating Datum Marker Buoy
SMC	SAR Mission Coordinator
SMS	Safety Management System
SMTJ	Special Maritime and Territorial Jurisdiction
SNO	Statement of No Objection
SOA	Speed of Advance
SOG	Speed Over Ground
SOLAS	Safety of Life at Sea
SO-OP	Auxiliary Division Operations Officer
SOP	Standard Operating Procedure
SOPA	Senior Officer Present Afloat
SOPEP	Shipboard Oil Pollution Emergency Plan
SOQ	Sailor of the Quarter
SOS	Save Our Ship
SPC	Special Purpose Craft
SPC (HWX)	Heavy Weather Special Purpose Craft
SPC (LE)	Special Purpose Craft (Law Enforcement)
SPE	Severity-Probability-Exposure
SPF	Sun Protection Factor
SPOC	SAR Point of Contact
SPS	Standard Positioning Service
SRA	Short-Range Aids to Navigation



ACRONYM	DEFINITION
SROE	Standing Rules of Engagement
SRR	Search and Rescue Region
SRR	Short-Range Recovery
SRS	Synchronous Reference Sensor
SRU	Search and Rescue Unit
SS	Square Search
SSB	Single Side Band
SSB-HF	Single Side Band - High Frequency
SSL	Standard Support Level
SSM	Support and Special Mission
SSMR	Shore Station Maintenance Record
SSPO	Station Support Petty Officer
STA OPS	Station Operations
STAN & RFO	Readiness and Standardization Program
STANT	Station Aids to Navigation Team
STAR	Standard Automated Requisitioning
STCW	Standards of Training, Certification and Watchkeeping for Seafarers
STTR	Short Term Resident Training Request
STU III	Secure Telephone Unit
SURPIC	Surface Picture
SWE	Service-wide Exam
SWL	Safe Working Load
TACON	Tactical Control
TAD	Temporary Assigned Duty
TAIT	Temporary Access Inventory Tool
TANB	Trailerable Aids to Navigation Boat
TB	Tuberculosis
TBSA	Total Body Surface Area
TC	Technical Committee
TCM	Telecommunications Manual
TCOW	Telecommunications Watchstander
TCT	Team Coordination Training
TD	Temporary Duty



ACRONYM	DEFINITION
TD	Time Difference
TFC	Total Fuel Consumption
THREATCON	Threat Conditions
TMT	Training Management Tool
TOI	Target of Interest
TPSB	Transportable Port Security Boat
TQC	Training Quota Management Center
TRACEN	Training Center
TRATEAM	Training Team
TRS	Timing Reference Sensor
TSN	Track Line Non-Return Search
TSR	Track Line Return Search
U/W	Underway
UCMJ	Uniform Code of Military Justice
UEG	Unit Environmental Guide
UEPH	Unaccompanied Enlisted Personnel Housing
UHF	Ultra High Frequency
UMI	Universal Marine Interface
UMIB	Urgent Marine Information Broadcast
UOF	Use of Force
UPF	Unit Performance Factor
UPH	Unaccompanied Personnel Housing
UPS	United Parcel Service
USBP	United States Border Patrol
USC	United States Code
USFWS	U.S. Fish and Wildlife Service
USPS	U.S. Power Squadron
USWMS	Uniform State Waterway Marking System
UTB	Utility Boat
UTBSC	Utility Boat Systems Center
UTC	Coordinated Universal Time
UTL	Utility Boat Light
UTM	Utility Boat Medium



ACRONYM	DEFINITION
UTS	Unit Travel System
UV	Ultraviolet
VHA	Variable Housing Allowance
VHF	Very High Frequency
VRM	Variable Range Marker
VRO	Variable Ratio Oiler
VRP	Vessel Response Plan
VS	Sector Search
VSC	Vessel Safety Check
VTS	Vessel Traffic Services
WP	Working Punt
WAAS	Wide Area Augmentation System
WAMS	Waterways Analysis and Management System
WC	Wellness Coordinator
WLIC	Construction Tender
WLL	Working Load Limit
WPB	Patrol Boat
WR	Wellness Representative
WWM	Waterways Management
XO	Executive Officer
XPO	Executive Petty Officer
XTE	Cross Track Error